

# ALESIS

## QS7.1 and QS8.1

# Reference Manual

---

# INTRODUCTION

Thank you for purchasing an Alesis QS7.1/QS8.1 64-Voice Expandable Synthesizer. It's a powerful instrument and we're sure you will find it exciting to use. The more you know about it the more you'll be able to do, so we recommend that you make good use of this manual.

But most importantly, don't forget to have fun! (There's a good reason they call what musicians do *playing*.)

## HOW TO USE THIS MANUAL

No manual can cover the needs of all musicians. There are simply too many of you, and your needs are too different. But we've tried to make this a document that will teach you what you need to know while encouraging you to explore new and interesting territory.

It is divided into eleven parts. How many of these sections you need to read will depend on what you want to do with your QS.

**Part 1: SETUP & CONNECTIONS** covers how to hook up your QS so it can be turned on and played. This section also contains useful audio basics, some tips on wiring and power, and directions for connecting your QS to other MIDI gear.

**Part 2: OVERVIEW** introduces the front panel controls and LCD, along with the terms and internal structures that every QS owner ought to know. Here is where you'll learn what all the buttons do, and how the sounds are organized. This chapter also covers the Card expansion options you have available.

**Part 3: FIRST SESSION** starts you playing.

**Part 4: BASIC OPERATION** takes everything in the First Session one step further. After covering this material you'll be a QS performance wizard, fully versed in how to use the instrument's Programs and Mixes and how to change Global settings. It'll also take you through the basics of using the [STORE] button to save your edits, how to go about naming them, and the procedures for playing back sequences from a card.

**Part 5: MIDI** is for players who want to use their QS for MIDI performance and sequencing. Because it's relevant, you'll also find a little here about the very top level of Mix editing. Sys-ex transfer operations are also covered in this section.

**Part 6: EDITING EFFECTS** will show you how to modify the the matrix of effects processors that are built into your QS. This is useful to know even if all you want to do is "play the presets," because even if you love a particular sound you might find that its current processing doesn't quite fit in with your music. Need to lengthen or shorten a Program's reverb time? Extend a delay? Make an echo louder? Or maybe even shut the effects completely off, so you can run a raw signal into your mixing deck or external effects processor? This is where you'll find the answers.

**Part 7: EDITING MIXES** takes you to the next level of editing power, showing you how to change the preset Mixes and put together new ones of your own. It also explains the parameters which give the QS its strength as a master MIDI keyboard.

**Part 8: EDITING PROGRAMS** gets deep into the instrument. If you are interested in pushing the QS synthesis engine to the max — and it's a powerful engine, it really is — then you'll want to study this section very closely.

**Part 9: EXTRAS** includes all sorts of fun and useful information that doesn't fit neatly into the other sections. This is where to look for discussion of RAMcards, Sound Bridge, the QS CD-ROM, and other things of general interest.

**Part 10: APPENDICES** contains reference material on service and maintenance, troubleshooting, and the QS's MIDI Implementation.

**Part 11: Index** lists some key parameters and concepts alphabetically, along with the page numbers on which you will find the most information about the item you are researching.

## MANUAL CONVENTIONS

All buttons, knobs, and switches on the QS are referred to in bracketed capital letters that match the instrument's actual markings. Here are some examples:

[PROGRAM] means the button to the right of the LCD that says "PROGRAM" on it.

[◀ PAGE] and [PAGE ▶] refer to the two buttons on the left of the LCD that have left-and-right cursors on them.

[CONTROLLER D] is the slider on the right side of the slider grouping, with "D" printed underneath.

[00 PIANO] refers to the leftmost button in the top row of numbered buttons. *Sometimes this will be shorthanded as [00], depending on what's being discussed.*

[PITCH] is the control wheel at the left side of the instrument.

And [SUS PEDAL] is the rear panel jack you'd plug your sustain pedal into.

---

## Unpacking and Inspection

The shipping carton for your QS should contain the following items:

- QS (with the same serial number as shown on the shipping carton)
- Sustain pedal
- AC Power Cable
- Computer CD-ROM containing software
- This instruction manual, plus Mix and Program lists and a Quick Start guide
- Alesis warranty card



*If you haven't filled out your warranty card and mailed it back to us, please take the time to do so. This will help us give you the best support we possibly can.*

# CONTENTS

<b>Part 1: SETUP &amp; CONNECTIONS .....</b>	<b>9</b>
AC Power.....	9
Audio.....	10
MIDI.....	12
Direct Computer Link.....	14
Pedal and Footswitch Hookup.....	16
Digital Audio/Optical Hookup.....	16
48 kHz Input.....	17
<b>Part 2: OVERVIEW .....</b>	<b>19</b>
A Quick Tour Of The Front Panel.....	19
Programs, Mixes, And Banks.....	24
The Performance Controls.....	26
PCMCIA Expansion Cards.....	28
<b>Part 3: FIRST SESSION .....</b>	<b>29</b>
Powering Up.....	29
Playing the Demo Sequences.....	29
Playing Programs.....	30
Playing Mixes.....	31
The Performance Controls, Pt. II.....	33
Transposing The Keyboard.....	33
Performance Transposition Chart.....	34
<b>Part 4: BASIC OPERATION.....</b>	<b>35</b>
Recap.....	35
The Double-Button Press Trick.....	35
Copying Existing Programs And Mixes To A New Location In The User Bank.....	36
...Or To A New Location On A Card Bank.....	36
Changing The Programs In A Mix.....	37
Storing Altered Mixes To The User Bank (Or To A Card).....	37
Storing Altered Programs To The User Bank (Or To A Card).....	37
Changing The Name Of A Program Or Mix.....	38
Compare Mode.....	38
Playing Sequences From A Card.....	39
The Global Settings (And How To Change Them).....	40
<b>Part 5: MIDI .....</b>	<b>49</b>
The Power of Mix Mode.....	49
Using an External Sequencer.....	50
Program Assign for each MIDI Channel.....	52
Sending and Receiving Bank Select Messages.....	52
Using the QS6.1 as a Master Keyboard.....	54
Saving Programs via MIDI Sys Ex.....	58
Editing Programs via MIDI Sys Ex.....	59
<b>Part 6: EDITING EFFECTS .....</b>	<b>61</b>
Basic Info.....	61
Entering Effects Edit Mode From Program Mode.....	62
Entering Effects Edit Mode From Mix Mode.....	62
Navigating In Effects Edit Mode.....	63
Selecting From Among The Available Effects Patches In A Mix.....	63
The "FX Program Change via MIDI" function.....	64
How The Display Changes When You Alter An Effect.....	65

---

Storing Effect Patches In Program Mode.....	65
Storing Effect Patches in Mix Mode.....	65
Copying Effects From One Program To Another.....	66
Keeping Track: The Interaction Of Effects, Programs, And Mixes.....	67
Picking An Effect Configuration.....	67
Configuration #1: 1 REVERB.....	68
Configuration #2: 2 REVERBS.....	70
Configuration #3: LEZLIE+REVERB.....	72
Configuration #4: 1 REVERB+EQ.....	73
Configuration #5: OVERDRIVE+LEZLIE.....	74
Routing Sounds or Programs Through The Effects Only.....	75
Setting Effect Send Levels.....	76
If The Send Inputs Clip.....	76
[00] to [30] —Effect Sends 1 - 4.....	76
EQ.....	77
Mod.....	78
Lezlie.....	81
Pitch.....	83
Delay.....	89
Reverb .....	90
Overdrive.....	96
Effect Mix.....	97
<b>Part 7: Editing Mixes.....</b>	<b>99</b>
What is a Mix?.....	99
Polyphony in Mix Play Mode.....	99
Program Assign for each MIDI Channel.....	99
Mix Edit Mode.....	100
Understanding the Edit Buffers.....	101
Level Setting for Each Program.....	102
Pitch.....	103
Effect.....	103
Keyboard/MIDI.....	104
Controllers.....	105
Setting the Range.....	106
Naming a Mix.....	106
<b>Part 8: Editing Programs.....</b>	<b>107</b>
Overview.....	107
The “Normalized” Synth Voice.....	107
How the QS6.1 Generates Sound.....	108
Program Sound Layers.....	108
QS6.1 Signal Flow.....	109
About Modulation.....	111
About Signal Processing.....	112
Drum Mode.....	113
Storing Your Edited Programs.....	114
Program Edit Functions.....	115
Voice.....	116
Muting and Unmuting Sounds.....	116
Level.....	119
Pitch.....	120
Filter.....	123
Amp/Range.....	126
Pitch Envelope.....	130
Filter Envelope.....	133
Amp Envelope.....	136

---

---

Name.....	138
Mod 1 – Mod 6.....	139
Pitch LFO.....	144
Filter LFO.....	146
Amp LFO.....	147
Tracking Generator.....	149
Programming Drum Sounds in Drum Mode.....	151
Voice.....	151
Level.....	153
Pitch.....	153
Filter.....	154
Amp/Range.....	154
Amp Envelope.....	155
Mute Group.....	155
Special Programming Functions.....	156
Copying Sounds.....	156
To Audition Programs Before Storing.....	157
<b>Part 9: Extras.....</b>	<b>159</b>
A Word About the QS CD-ROM.....	159
Sound Bridge™.....	159
Using PCMCIA Expansion Cards.....	160
Saving the User Bank to a PCMCIA Card.....	160
Loading a Bank from an External Card.....	161
Storing an Individual Program or Mix.....	162
Loading an Individual Program or Mix.....	162
Card Storage Ramifications.....	163
More about SRAM Cards.....	164
SRAM Cards and Mix Mode.....	164
<b>Part 10: Appendices.....</b>	<b>165</b>
Appendix A.....	165
Troubleshooting.....	165
Recovering From A “Crash”.....	166
Re-initializing.....	166
Checking The Software Version.....	167
Maintenance/Service.....	167
Cleaning your QS6.1.....	167
Preventative Maintenance.....	167
Refer All Servicing to Alesis.....	167
Obtaining Repair Service.....	168
Appendix B: MIDI Supplement.....	169
MIDI Basics.....	169
MIDI Hardware.....	169
MIDI Message Basics.....	170
Channel Messages: Mode Messages.....	170
Channel Messages: Voice Messages.....	170
Continuous Controllers List.....	171
System Common Messages.....	172
General MIDI.....	172
MIDI Implementation Chart.....	174
Appendix C: Parameters Index.....	175
Program Edit Parameters.....	175
Mix Edit Parameters.....	177
<b>Part 11: Index.....</b>	<b>179</b>

---





**PART 1****SETUP & CONNECTIONS****AC POWER****HOOKUP**

Your QS7.1/QS8.1 is set to work with the voltage of the country to which it was shipped (either 110 or 220V, 50 or 60 Hz) and comes equipped with the appropriate power cable.

Hooking that cable up is simple.

- Make sure your QS is turned off.
- Plug the female (jack) end of the power cable into the QS's power socket.
- Plug the male (plug) end into a source of AC power. It's good practice *not* to turn the QS on until all other cables are hooked up.

The IEC-spec power cable included with your QS is designed to connect to an outlet with three holes, the third of which — the round one — is the ground connection. This connection is an important safety feature: it keeps the QS's chassis at ground potential, preventing accidental shocks.

Unfortunately, not all three-hole sockets are properly grounded. We recommend that you use an AC line tester to check the ground connection on any socket you may use, just to be on the safe side. If you find an ungrounded outlet, consult with a licensed electrician about getting the problem fixed.

- ★ *Avoid using ungrounded outlets. Plugging the QS into an ungrounded outlet can be hazardous. The same goes for "lifting" the unit off ground by using a three-to-two plug adapter. Don't do it!*
- ★ *Alesis cannot be responsible for any problems that might be caused by using the QS with improper AC wiring.*

**LINE CONDITIONERS AND PROTECTORS**

The power coming through some AC lines contains voltage surges, spikes, or transients that can stress your gear, causing failure or malfunctions. Although the QS is designed to tolerate typical voltage variations, it isn't invulnerable. So if the power in your area is particularly bad (or if you are out playing live gigs) you will probably want to take precautions. You have three basic options:

- **Line spike/surge protectors.** These relatively inexpensive devices are designed to protect against strong surges and spikes. They act somewhat like fuses and will have to be either replaced or reset (depending on the unit) if they've been hit by an extremely strong spike.

- **Line filters.** These cost more than simple spike/surge protectors, but may be worth it depending on your situation. Along with surge protection they offer circuits that can remove some line noise — things like dimmer hash, transients from other appliances, etc.
- **An Uninterruptible Power Supply (UPS).** This is the most expensive way to go, but it is also the best. Your typical UPS offers complete line protection/filtering and throws in emergency battery power that will come on instantly if there is a power outage. This will prevent anything in RAM-only memory from getting lost, and enable you to take the time to shut down everything properly. That last step is very important. You should always turn everything in your rig *physically* off when the power goes out — otherwise you risk serious gear and/or speaker damage from the current surge that takes place when power is finally restored.

## AUDIO CONNECTIONS

The QS has two Main outputs and a stereo headphone output. These make for several possible hookups:

- **Mono.** To run in mono, connect a single mono cable from one of the QS's [MAIN] output jacks to either a mono amp or an individual mixer input. (You can use either the [LEFT MAIN] or the [RIGHT MAIN] output jack.) Please note that with this connection you will only be hearing one channel, so any Programs or Mixes designed for stereo output will sound incomplete or diminished.
- **Stereo.** To run in stereo, connect two mono cords (one each from the [LEFT] and [RIGHT] output jacks) to either (A) a stereo amp system or (B) two separate mixer inputs. For full effect, make sure that these inputs are panned hard left and right.
- **Dual Stereo/Four Individual Outs.** Connect two mono cords from the [LEFT] and [RIGHT] MAIN OUTPUT jacks and two mono cords from the [LEFT] and [RIGHT] AUX OUTPUT jacks to a dual stereo amplification system, or four mixer inputs.
- **Stereo Headphones.** To listen over headphones, plug a set of high-quality stereo headphones into the headphones  jack on the rear panel. The volume for the headphone output is controlled by the front panel [VOLUME] slider. Some headphones have a higher electrical resistance than others; if the sound level seems too low even with the [VOLUME] slide up full, try a different set.

## LEVELS

To get the highest audio quality when performing or recording, set your QS's [VOLUME] slider all the way up. If the resulting signal is too loud ("hot") for your mixer or

recording deck, lower the input level controls on those units until they are no longer clipping.

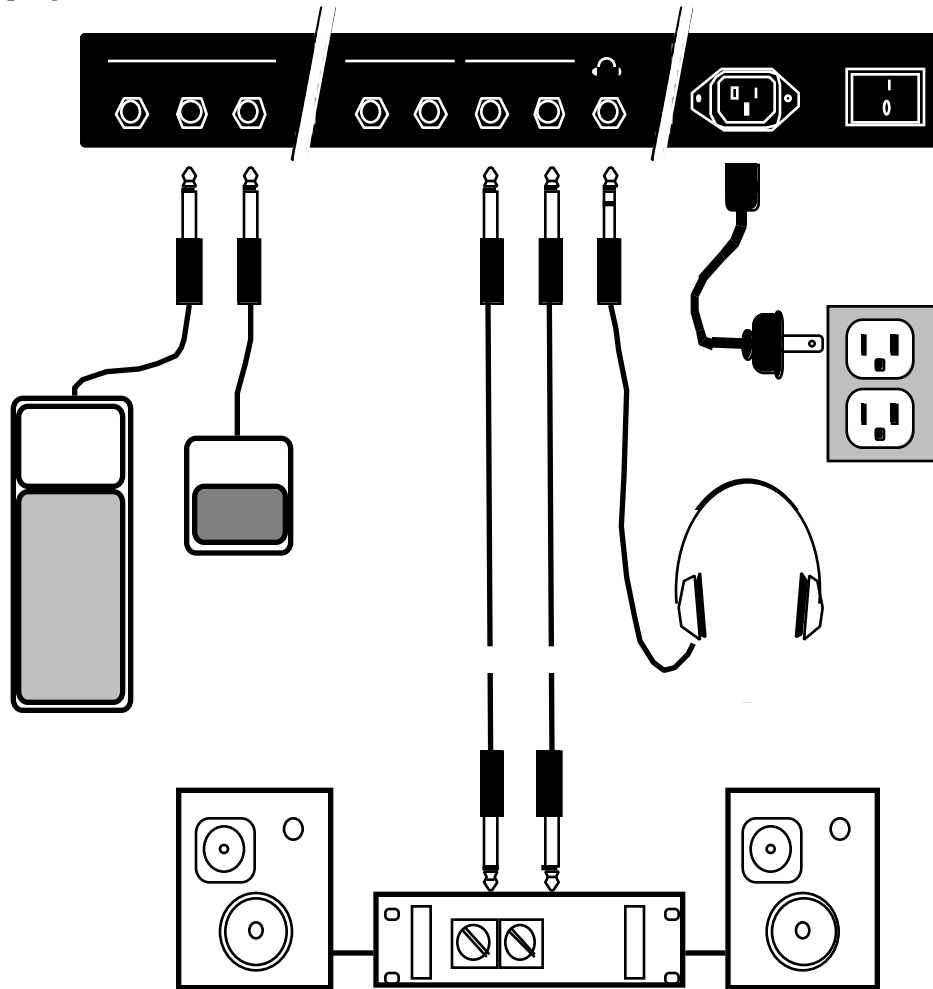

## AUDIO CABLES — SELECTION, ROUTING, AND CARE

The audio connections between your QS and the rest of your studio are your music's lifeline, so make sure you use high-quality cables. These should be low-capacitance shielded cables, with a stranded internal conductor and a low-resistance shield. Avoid cables with solid internal conductors.

Quality cables cost more, but they are worth it. If you want to the lowest possible noise and the best possible sound, there is no other way to go. As for what to do with them when setting up, here are some basic mistakes to avoid:

- Do not bundle audio cables with AC power cords. If you do, the audio cables will pick up hum from the AC line.

- Avoid running audio cables near such sources of electromagnetic interference as transformers, monitors, computers, etc.
- Don't run cables where they can be stepped on. Stepping on a cable will compress the insulation between the center conductor and shield, and over time this will degrade performance and reliability.
- Avoid twisting the cable or laying it out with sharp, right-angle turns.
- Never unplug a cable by tugging on the cable itself. Even if it has a "strain-relief" plug, you are likely to damage the inside wiring and connections. The best way to unplug a cable is to firmly grasp the body of the plug and then pull it straight outward.



*When connecting audio cables, or turning power on and off, make sure that ALL devices in your system are turned off and ALL volume controls are turned down. This is important. If you don't do this, you can create loud bursts of sound that might damage your speakers (or worse, your ears).*

## MIDI

### BASIC MIDI HOOKUP

MIDI is the standard data communication protocol for electronic musical instruments. If you aren't familiar with MIDI, see *Part 5: MIDI* and *Part 10: Appendices* to learn more about how it works. Meanwhile, here's all you need to know to get wired up.

The QS has three MIDI connectors:

- **MIDI IN.** This port is for receiving MIDI information (notes, program changes, etc.) from another source, such as another MIDI keyboard, an alternate controller, or a computer.
- **MIDI OUT.** This port is for sending MIDI information to another MIDI keyboard, sound module, or computer.
- **MIDI THRU.** This port is for passing on MIDI information received by the MIDI IN port. In simple MIDI setups, the THRU port is used to connect additional devices that will all be "listening" to the same source.

Here are four typical MIDI setups for your QS, and the appropriate cable connections for each of them:

- **As Slave.** To play your QS from any other MIDI device (keyboard, drum pad, guitar or bass controller, sequencer, etc.), just run a standard 5-pin MIDI cable from the control device's MIDI OUT to the QS's [MIDI IN] jack.

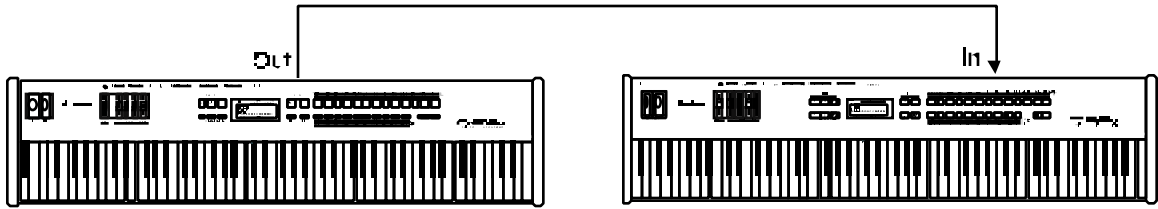

- **As Controller.** To play other MIDI devices from your QS, run a MIDI cable from the QS's [MIDI OUT] jack to the MIDI IN of the device you want to control.

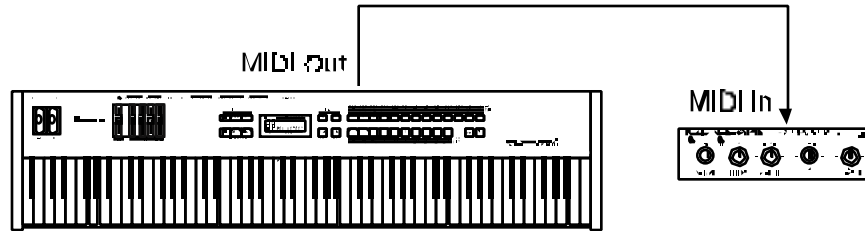

- **As a Link in a "daisy chain."** If you are using the QS in the middle of the MIDI chain (example: as the second unit of a three device chain), you'll need two MIDI cables. Attach one from the MIDI OUT of the chain's first device to the [MIDI IN] jack of the QS; and then attach the other from the QS's [MIDI THRU] jack to the MIDI IN of the chain's third device.

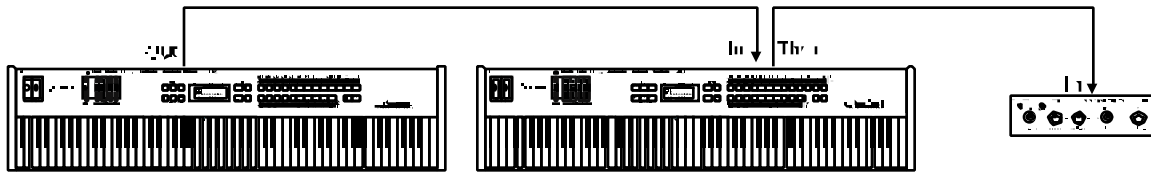

- **As part of a computer-based MIDI Network.** If you are using a computer for sequencing and/or programming, you'll want to be able to play data into your computer from your QS, and receive data back as well. This will take two MIDI cables. Attach one from the MIDI OUT of the computer's MIDI interface to the [MIDI IN] jack of the QS; and then attach the other from the QS's [MIDI OUT] jack to the interface's MIDI IN.

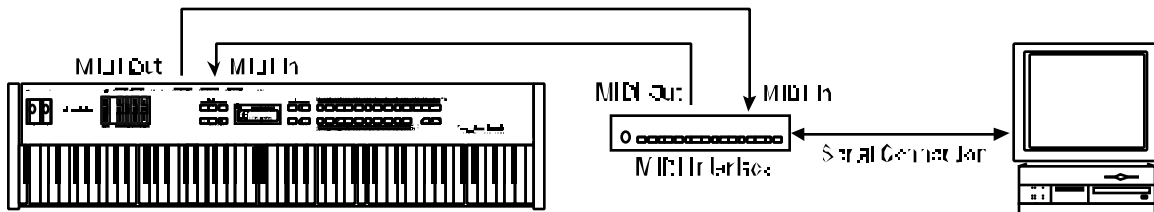

## DIRECT COMPUTER LINK

The QS can communicate directly with Mac or PC computers via its [SERIAL PORT] connector. Using this connection eliminates the need for a MIDI cables and a separate MIDI interface.

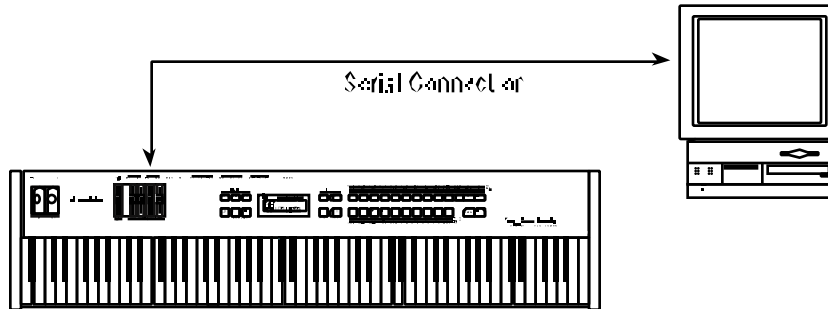

Here's how it works:

- 1) Run a single serial cable from your computer's serial port to the [SERIAL PORT] connector on your QS.
- 2) Set the rear panel [◀ PC / MAC ▶] switch to either PC or MAC, depending on what kind of computer you are using.
- 3) Set your QS to listen to data over this direct serial connection, instead of MIDI. To do this, press [EDIT SELECT] to begin editing; then press [BANK ▶] to access Global Edit Mode; then press [◀ PAGE] until the lower line of the LCD reads I/O. (If you overshoot, just press the [PAGE ▶] button to get back.) Once there, use the [VALUE] buttons to change the setting from MIDI to whatever best matches your computer. There are three options:
  - **PC 38.4Kbd.** Use this setting if your computer is a PC and its serial port runs at 38.4 kilobaud.
  - **PC 31.25Kbd.** Use this setting if your computer is a PC and its serial port runs at 31.25 kilobaud.
  - **MAC 1MHz.** Use this setting if your computer is a Macintosh.

*Please note that if the rear-panel selection switch is set to [MAC], your QS will not show you the two PC choices. Likewise, if the switch is set to [PC], then the Mac setting will not show up in the display.*

## **IBM® PCS AND COMPATIBLES RUNNING WINDOWS®**

If you want to link your QS directly with a PC or PC-Compatible, you'll need special serial driver software and cabling.

You've already got the driver software — it's in the \ALESIS\ASDWIN directory on the CD-ROM that came with your QS. (If you don't have a CD-ROM drive in your computer, call Alesis Product Support and ask them to send you the software on a 3-1/2 inch floppy disk.) Complete installation instructions come with the driver software. The procedure will vary depending on your version of Windows.

The special cable can be purchased through Alesis Product Support. It has a DIN8 connector on one end and either a DB9 or DB25 connector on the other end (depending on the type of connector that is on your PC.) The DIN8-to-DB9 cable is part # 9-96-1290. The DIN8-to-DB25 cable is part # 9-96-1291.

Be aware that many PCs have more than one serial port, and some have *both types* of connector. Before you order a cable from us you will need to (A) identify the port you wish to hook up to, and (B) make certain it is not already in use by the computer.

## **MACINTOSH™**

You don't need a special cable to make a direct connection between your QS and a Mac. Any standard Mac DIN-8 cable will do.

You will, however, have to choose between using the MODEM or PRINTER serial port on the Mac. Plug into whichever one you aren't already using, and then make sure your MIDI software's port selection is set to match.

If both ports are already in use, you can either (A) temporarily disconnect your modem or printer, or (B) buy a multiple serial port box that will let you hook everything up to your Mac and switch among these serial devices as needed.

**NOTE:** If you want to use the printer port for your direct serial link, first make certain that AppleTalk is disabled.



## PEDAL AND FOOTSWITCH HOOKUP

The QS keyboard has three back-panel pedal jacks, marked [SUS PEDAL], [PEDAL 1] and [PEDAL 2].

[SUS PEDAL] is designed to work with any standard momentary footswitch. It doesn't matter whether the footswitch is normally open or closed, so long as you plug it into the jack *before* powering up your QS; the instrument will automatically sense the footswitch's polarity and calibrate itself accordingly.

[PEDAL 1] and [PEDAL 2] are designed to work with a Roland EV-5 volume pedal (or its equivalent).

The QS's factory defaults assign sustain to the [SUS PEDAL] jack and overall instrument volume to the [PEDAL 1] jack, but you can change these settings at any time if you want to. There are lots of interesting possibilities to explore. A starter example: using a footswitch to turn vibrato on in a program, and using a volume-type pedal to control vibrato speed.

*If your sustain footswitch responds backwards (i.e., notes sustain unless the footswitch is pressed), then turn off your QS and make sure the footswitch plug is fully inserted into the [SUS PEDAL] jack. When it is, turn the instrument's power back on while keeping your foot off the footswitch.*

## DIGITAL AUDIO/OPTICAL HOOKUP

The QS can output digital audio directly into an Alesis ADAT, ADAT-XT, or ADAT-compatible multitrack digital recorder via fiber optic cable.

The QS's [DIGITAL OUT] carries all four audio outputs of the QS (Main and Aux, Left and Right) on a single fiber optic cable. Fiber optic cables of various lengths are available from your Alesis dealer. The model OC cable is 5 meters long and is the maximum length recommended.

Note: This will not plug directly into a tape deck which uses S/PDIF or AES/EBU for its digital input! A digital audio format converter of some sort must be used.

To hook up the optical cable between the QS and an ADAT-XT:

- ⑩ Remove the two pieces of clear plastic, tubular sleeving (if present) that protect the tips of the optical cable plug.
- 🔌 Insert one cable end into the QS [DIGITAL OUT] and the other end into the ADAT-XT's DIGITAL IN.

To test the cable and QS digital output, plug one cable end into the QS. The other end should emit a soft red light (it is not dangerous to look directly at this light).

## RECORDING DIGITAL AUDIO

Once the fiber optic connection is made between the QS and ADAT-XT, the QS will output audio on the first four channels of the digital bus (the bus is capable of handling eight channels of digital audio). The MAIN [LEFT] and [RIGHT] outputs

are routed to channels 1 and 2, while the AUX [LEFT] and [RIGHT] outputs are routed to channels 3 and 4. Note that the [VOLUME] slider does not control the level going to the ADAT-XT. Volume control must happen via MIDI or a Pedal plugged into the Pedal 1 jack.

When recording to ADAT-XT (or some other digital audio recorder), it must be set to “slave” to the 48kHz clock embedded in the digital audio which the QS is sending. This clock can be set to either 48kHz or 44.1kHz, as determined by the Clock function (found in Global Edit Mode, Page 19). The Clock function has four settings: Int 48kHz, Int 44.1k, Ext 48kHz and Ext 44.1k. The default setting is Int 48kHz, which is suitable when the digital recorder is using the 48kHz sample rate. However, if the recorder is using the 44.1kHz sample rate, the Clock function should be set to Int 44.1k. This ensures that the QS will be in tune with previously recorded material. See page 47 in *Chapter 4: Basic Operations* for more information on the Clock parameter.

## 48 KHz In

If your ADAT system has an Alesis BRC Remote Controller, the QS’s digital clock must be synchronized to the clock coming from the BRC. This requires that a connection be made providing the clock signal to the QS and that the QS’s Clock function be set to either one of its two external settings (Ext 48kHz or Ext 44.1k).

Connect a BNC-to-BNC cable (such as the Alesis BN cable) between the BRC’s 48 kHz CLOCK OUT and the QS’s [48 KHZ IN]. Set the Clock function to either Ext 48kHz if the BRC is set to 48kHz, or Ext 44.1k if the BRC is set to 44.1kHz (“Pitched Down” to -147).

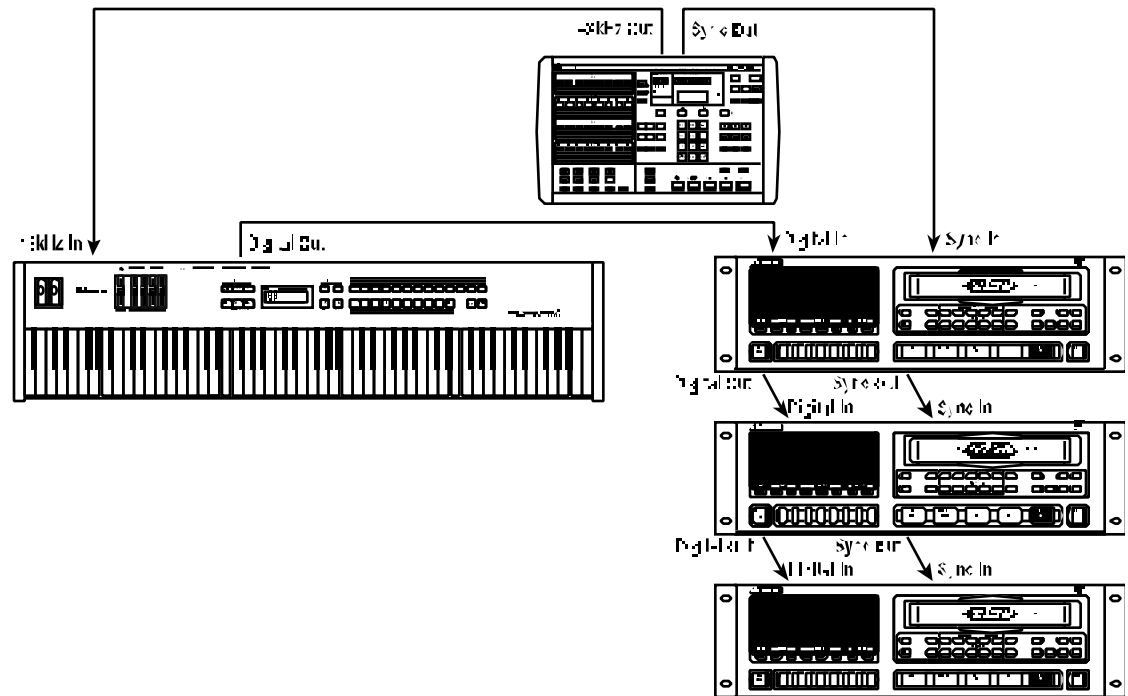

*Tip:* With this type of connection, the ADAT-XT tracks will remain in tune with the QS even when the BRC’s pitch value is adjusted.

*Note:* When using ADAT-XTs without the BRC, it is not necessary to connect the 48 kHz Clock. If set up properly, the XTs will “slave” to the QS’s Digital Output.

## PART 2

# OVERVIEW

## A QUICK TOUR OF THE FRONT PANEL

### THE WHEELS

At the far left of the front panel you will find two powerful controllers:

- **The [PITCH] wheel.** Move this control up or down to expressively bend the pitch of the synth.
- **The [MODULATION] wheel.** Move this control to cause interesting sonic changes in the current Program or Mix.

Sometimes you won't hear anything happen when you use the [MODULATION] wheel. In these cases, either (A) the current Program or Mix isn't programmed to respond to modulation, or (B) modulation is tied to a function that is currently off. Here's an example of the latter: if the [MODULATION] wheel is programmed to control chorus *speed*, but chorus *depth* is currently set at zero, then moving the [MODULATION] wheel won't do anything audible.

### THE SLIDERS

Moving to the right, you will see 5 different sliders:

- **The [VOLUME] slider.** This fader raises and lowers the QS7.1/QS8.1's audio output level.
- **[CONTROLLERS A, B, C, and D].** These faders are programmable and can be used to give you hands-on control of many different parameters. What they do will vary depending on how the Program or Mix has been designed. As you move them, the LCD gives you visual feedback in the form of small vertical bar-graphs. *Please note: this only happens if a control function is assigned to the slider being moved. That means the quickest way to find out which sliders are working in a given Program is to push all four sliders up while watching the display.*

During editing, the [CONTROLLER D] slider serves as a data entry control.

## THE EDIT MODE BUTTONS

There are 6 buttons grouped together at the immediate left of the display:

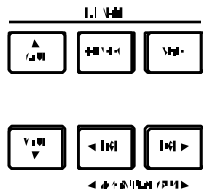

- [**▲ VALUE**]. When you are editing, this button increments the selected value. At all other times it steps you forward through the available Programs or Mixes, depending on which mode you've selected.
- [**VALUE ▼**]. Same as [**▲ VALUE**], except that it decrements values and steps backward through Programs and Mixes.
- [**EDIT SELECT**]. This button takes you into Edit Mode. To get back out, press either [**MIX**] or [**PROGRAM**].
- [**STORE**]. A true multi-purpose control. It is involved in making MIDI sys-ex transfers, in saving and loading both User and Card Banks, in copying Effects patches, and when initializing individual Sounds within a Program. When editing, this is the button you'd press to store an altered Program or Mix to a selected location in the QS's memory. In normal performance it gives you a quick way to copy the current Program or Mix to a new location.
- [**◀ PAGE**]. When editing, this button cycles you backward through the available "pages" for the current parameter (there's an indicator in the upper right of the LCD that tells you what page you are on). In Program Mode, this button changes your QS's basic MIDI channel. In Mix Mode, it is used to display the Programs assigned to different MIDI channels, so that you can change these assignments on the fly.
- [**PAGE ▶**]. Same as just above, except that it cycles you forward instead of backward.

## THE DISPLAY

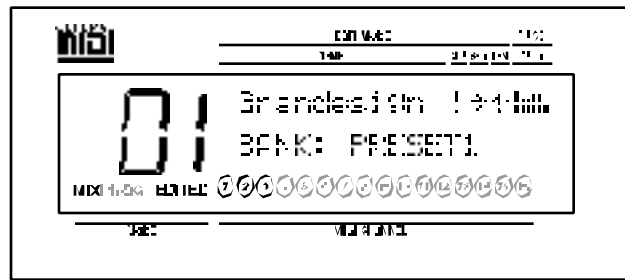

The large backlit LCD in the center of the front panel gives you visual feedback as you work. What it shows will vary depending on the mode you are in.

Let's go over what the different areas of the LCD "tell" you.

- 1) The big numbers on the left side of the LCD show you which Program or Mix you're currently editing or playing.
- 2) The top line of the display shows the NAME of the Program or Mix while you're in Play Mode. It also gives you the name of the selected Function when you're in Edit Mode.
- 3) If you look closely at the silkscreening around the LCD's "bezel" (the raised, clear plastic cover between it and the dusty outside world), you'll notice some abbreviations like "CLP" or "TRN" alongside the word "NAME". Here is what they stand for:
  - CLP:** An exclamation point (!) will appear in this area of the LCD if the QS's signal clips internally. You'll only see this in Program or Mix Modes (not while you're editing).
  - SEQ:** A blinking arrow (->) will appear in this area of the LCD if you have triggered a card sequence. When the sequence stops, the arrow will disappear.
  - TRN:** An up or down arrow will appear in this area of the LCD if you have transposed the keyboard up or down.
  - ABCD:** If a Program or Mix has any of the four faders active, you can move them and see a reaction in the LCD under these four letters. The four vertical bar graphs represent the [CONTROLLER A-D] slider positions. This area of the LCD will also display the "page" numbers when you are in any of the Edit Modes.
- 4) The middle line does *triple* duty. In Play Mode it tells you which Bank the sound you're using came from. In Edit Mode it gives you the name of the parameter you're editing. And in Mix Program Select mode, it lets you know which QS Program is assigned to which MIDI channel. More on that later in the manual.
- 5) These words let you know which Mode you are in. You'll see them alone or in combination depending on where you are. The word "EDIT" changes to "EDITED" when you change a value in one of the Edit Modes.
- 6) The numbers along the bottom are the MIDI channel numbers. In Program Mode you'll only see one channel number lit at a time. In Mix Mode you'll see two or more. When activity is happening on a given channel, a circle will light up around that MIDI channel's number. This is true whether the information is generated from the QS's keyboard or comes in via the MIDI In jack.

## THE PLAY MODE BUTTONS

There are 4 buttons grouped together at the immediate right of the display:

- **[MIX]**. This button takes you to Mix Mode.
- **[PROGRAM]**. This button takes you to Program Mode.
- **[◀BANK]**. In Program and Mix Modes, this button cycles you backward through all available Banks. In Edit Mode this becomes the [COMPARE] button, which shifts between the original and edited versions of a Program or Mix, so you can hear both while you make your changes.
- **[BANK▶]**. In Program and Mix Modes, this button cycles you forward through all available Banks. In Edit Mode it becomes the [GLOBAL] button, taking you to 18 pages of controls that affect the overall operation of your QS (including Master Tune, Controller Assignments, Keyboard Response Curves, and more).

## THE SELECTION BUTTONS

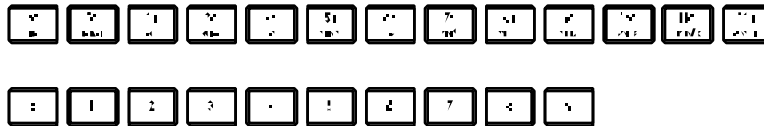

There are 23 buttons grouped together at the right side of the front panel, arranged in two rows (an upper row of 13, and a lower row of 10). These [SELECTION] buttons are used to quickly choose among Programs, Mixes, Sound parameters, MIDI channel assignments, etc. — whatever is available in the QS's current mode.

- **[00] through [120]**. When you are playing Programs or Mixes, these buttons jump your selection by tens — for example, if Program 79 is selected and you press [20], your QS will shift to Program 29. When you are editing, they select one of the three parameters printed just above them, depending on which Edit Mode you are in.
- **[0] through [9]**. When you are playing Programs or Mixes, these buttons jump your selection within the currently selected Sound Group — for example, if Program 24 is selected and you press [7], your QS will shift to Program 27. When you are editing, they select one of the three parameters printed just below them, depending on what Edit Mode you are in.

Most of these buttons are also used in Sequence selection and playback, as discussed on the next page.

## A WORD ABOUT THE SILKSCREENING

As we mentioned in the last section, if you look above and below the 23 [SELECTION] buttons you'll see a lot of words silkscreened on the front panel. We'll get into what they mean later. All you need to know now is:

- When you're in Mix Edit mode, find the word "MIX" at the outer edge of the buttons, and then follow along that level to find the various Mix functions.
- Do the same for Program and Effects Edit modes. The exception here is that there's no bottom row of functions for Effects Edit mode. In its place you have "Drum Sound", which means you use these buttons to select Drums in Drum Mode. The "Keyboard Sound" row calls up more Program Edit mode functions.

## THE SEQUENCE & TRANSPOSE BUTTONS

At the far right on the front panel are two buttons:

**[SEQUENCE]**. Pressing this button once puts your QS in Sequence Playback Mode. In this mode the [00] through [90] buttons select possible PCMCIA card Sequence Banks, and the [0] through [9] buttons trigger specific Sequences for playback. To exit without making a selection, just press [SEQUENCE] again.

**[TRANSPOSE]**. You can transpose the output of your QS by holding this button down and then pressing any key on the keyboard. The transposition limit is one octave in either direction. To return to normal operation, just stop pressing on the [TRANSPOSE] button. *Please note that any changes you make here will stay in place until you deliberately reset them to normal. This is done by holding the [TRANSPOSE] button and pressing the third C key from the left (also known as C3). To make it easy to locate, we've silkscreened that on the front panel just above the key.*



## PROGRAMS, MIXES, AND BANKS

Your QS comes with 1,140 built-in Programs and Mixes. At any time you can also add hundreds more just by putting QCards or RAMcards into the [PCMCIA EXPANSION CARD] slots.

That's a lot of different sounds!

In order to easily find the ones you need, you will need to know how they are arranged. Starting with...

### WHAT'S A PROGRAM?

A QS *Program* is a set of parameters which (A) create a specific sound and (B) can be recalled instantly at the touch of a button. There are lots of parameters, which is why many thousands of cool Programs are currently available from Alesis and third-party sources. And, of course, you can always edit these parameters yourself to create Programs that are uniquely your own.

There are 640 internal Programs, divided into 5 Banks of 128 Programs each (more about Banks in a moment). To get instant access to more Banks, simply insert an Alesis QCard into one or both of the [PCMCIA EXPANSION CARD] slots. You can also add Banks using RAMcards, assuming Program data is stored on them.

Each Program consists of from 1 to 4 different *Sounds* which can be combined and processed in many different ways: layered on top of one another, for example, or split up to cover different sections of the keyboard, or set to play (or not play) depending on how hard you strike a key.

*The number of Sounds being used by a Program has a direct effect on your QS's polyphony, because each Sound takes one Voice to play. If your current Program uses only one Sound, you'll be able to play 64 simultaneous notes. By contrast, a Program using two Sounds will run out of Voices twice as fast, limiting you to 32 simultaneous notes. And a Program that uses four Sounds will limit you to 16 notes of polyphony.*

### WHAT'S A MIX?

A *Mix* is a combination of Programs selected from the available Banks. Most Mixes have only two or three Programs in them, but you can put together as many as 16 if you want. You can also arrange them in a number of useful ways, creating layered combinations, split combinations, and more.

There are 500 internal Mixes, arranged 100 per Bank. More can be accessed at any time using expansion cards, as mentioned above for Programs.

For those of you who do MIDI sequencing, one of the most useful Mixes will be #00 in the User Bank. This is the *multi-timbral* Mix. It lets you assign different Programs

to each of 16 different MIDI channels, making it easy to build anything from a small pop/rock ensemble to a complete orchestra.

## WHAT'S A BANK?

A *Bank* is a collection of 128 Programs and 100 Mixes. There are five internal Banks available in the QS, and even more can be accessed if you have put QCards or RAMcards into one or both of the [PCMCIA EXPANSION CARD] slots.

The different banks are:

USER  
PRESET1  
PRESET2  
PRESET3  
GenMIDI  
Card A [*if in use; invisible if not*]  
Card B [*if in use; invisible if not*]

If a card has more than one Bank, the numbers will go up like so: CardA-1, CardA-2, CardA-3, etc.

While playing Programs or Mixes, the current Bank is named in the second line of the LCD display. To cycle through all the Banks that are available, press the [BANK] buttons on the front panel. You can also change Banks by using standard MIDI Bank Select commands (various values of Controller 0).

Two things to remember about Banks:

- 1) **Each Bank contains its own unique collection of Programs and Mixes.** This means that Program 10 in PRESET1 is different from Program 10 in PRESET3... although they may be similar if they belong to related Sound Groups (see the next page for a quick explanation of Sound Groups).
- 2) **A Mix can contain Programs from any Bank.** This includes Banks which might be on a QCard or an SRAM card. (If the Mix you've called up uses a card-based Program, make sure the Program's card is in the right expansion slot. If you have the wrong card in the slot, the Mix will call up the wrong Program. And if you have no card in the slot at all, that part of the Mix won't sound.)

## ABOUT SOUND GROUPS

To make things easier for you, we've broken down three of the five Banks into *Sound Groups*. There are 12 different Sound Groups with 10 Programs each, plus a 13th Sound Group with only 8 Programs. (This gives each Bank 128 Programs, as specified by the MIDI standard.) Each of these Groups is clearly marked on the [SELECTION] button that calls it up.

Why do we call them Sound Groups? Because they bring together Programs which are musically or sonically related, such as pianos [00], guitars [30], bass [40] and drums [120].

There are two Banks which differ from this default scheme:

- **The User Bank.** Straight from the factory, your QS's User Bank *is* organized in the same Sound Groups as the Preset Banks. But it needn't stay that way. Any User Bank you create for yourself (or collect from non-Alesis sources) might be organized very differently.
- **The General MIDI Bank.** This is organized to match the General MIDI standard, which puts Programs in a totally different order than that of our Sound Groups.

## THE PERFORMANCE CONTROLS

There are a number of expressive ways to control the sound of your QS while you are playing. They are:

- **Velocity.** This refers to how slow or fast you strike the keys. In most Programs, faster means louder. Velocity can also cause tonal changes in the sound, trigger new Sound layers in a Program, or do other things entirely. It all depends on what parameters are set to respond to it, and how.
- **Aftertouch.** Strike a key, hold it down...and then push it down a little harder. That's "aftertouch." (You'll also see it referred to as "Pressure" in some instruments and software.) Common uses include triggering changes in the pitch, tone, or volume of notes.
- **Pitch Bend Wheel.** Push the [PITCH BEND] wheel up and the pitch of your QS goes up. Push the wheel down, and it goes down. Let the wheel go and it springs back to center. A no-brainer, right? There have been pitch bend wheels on synths since the early days, so this function is properly familiar to you. Familiar or not, however, the simple fact is that bending pitch is a blast. Do it well and you can achieve incredible levels of emotional expression. One thing to remember: the amount of available pitch bend may vary from Program to Program.

- **Modulation Wheel.** The [MODULATION] wheel has also been around pretty much forever in synth design. It got its name because it is typically used to add varying levels of modulation (such as vibrato or tremolo) while you play. But it isn't limited to that. It can also be used to create "filter-opening" effects, to raise and lower volume, to pan signals from left to right (by crossfading between two separately hard-panned Sounds), to select between layers, to lengthen a reverb time, and lots more. It all depends on the individual Program settings.
- **Controller Sliders A-D.** These sliders can control any parameter that has been assigned to them (which may change from Program to Program). They are particularly useful when you want to have several related controls close at hand, for quick adjustment.
- **Sustain Footswitch.** If you connect a footswitch to the [SUS PEDAL] jack on your QS's back panel, you can use it to hold down notes after you lift your finger from the keyboard. In some Programs — piano and acoustic guitar sounds, for example — such held notes will naturally decay within a time set by the Program's parameters. In other Programs — like organs, woodwinds, and many synth sounds — they'll sound for as long as you keep the footswitch depressed.
- **Expression Pedal.** Think of this as a Modulation Wheel for your feet. All you have to do is connect a volume-type pedal to the [PEDAL 1] or [PEDAL 2] jacks on the QS's back panel, and you can use foot action to control pretty much any Program or Effect parameter that you want. Some obvious uses include changing volume, raising and lowering vibrato rates, increasing reverb depth or delay repeats, etc. But that's hardly the limit, so we invite you to see what you can come up with by experimenting for yourself.

# PCMCIA EXPANSION CARDS

Your QS7.1/QS8.1 is an expandable system. If you want access to more Sounds, Programs, Mixes, Effects, and Sequences, all you have to do is pop the appropriate memory card into one of the two [PCMCIA EXPANSION CARD] slots on the back panel. Using both slots you can add up to 16 megabytes of memory, effectively doubling the power of your instrument.

There are three different kinds of memory card that will work. All of them should be available through your Alesis dealer (if not, call us). They are:

- **SRAM cards.** Alesis offers a 512K SRAM card through our dealers that provides an additional eight banks of Programs and Mixes. You can use and edit these as you wish, or use the card as storage for your own creations. You can also order a blank version of this card from us (part # 7-10-1203).
- **QCards.** This is a series of ROM cards developed by us here at Alesis. Each is a self-contained universe of new samples, plus Programs and Mixes designed to take full advantage of them. Some of the cards available right now include Classical, Sanctuary, Vintage Keyboards, Vintage Synthesizers, HipHop, and EuroDance, with more coming out all the time.
- **FlashRAM cards.** These are the cards you'll need if you want to burn your own custom sample cards. FlashRAM cards are available in 2MB, 4MB, and 8MB sizes. Using Alesis's Sound Bridge software (*see Part 9: Extras*) you can organize all the necessary data on your PC or Mac and temporarily turn your QS into a "RAMburner" when you are ready to make your own card.

*Note: See the section entitled "Using PCMCIA Expansion Cards" in Part 9: Extras for exact card specifications.*

## PART 3

# FIRST SESSION

## POWERING UP

Once your QS7.1/QS8.1 is connected to an audio system of some kind, you are ready to play. Here's how to begin.

- 1) Make sure that all connections have been made correctly, and that the volume controls in your amplification system and QS are set to **zero**.
- 2) Throw the QS's rear-panel [ON/OFF] switch to ON (the up position). The display should light up and look something like this:

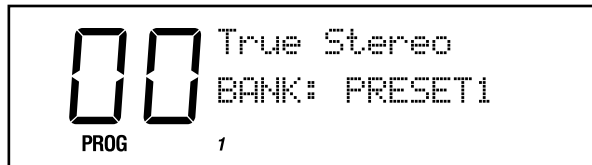

*If this isn't the first time your QS has been used, it may not say PROG in the bottom left of the display. Press the [PROGRAM] button once to change that.*

- 3) Push the [VOLUME] slider all the way up.
- 4) Turn on your amplifier or mixer, and gradually raise its volume while playing your QS. When the sound is as loud as you want, stop.

## PLAYING THE DEMO SEQUENCES

The QS has five built-in sequences designed to demonstrate its rich variety of sounds and signal-processing effects. To hear these at their best, make sure to run your QS in stereo (or else listen on headphones).

*Please note: Your QS doesn't send out MIDI messages during demo playback. In addition, the keyboard is disabled. You can listen to the demos, but you can't play along with them.*

- **To play all five sequences in order**, hold down the [MIX] button and press [0]. When all five have played, your QS will exit DEMO mode on its own.
- **To stop the demos at any point during playback**, press [MIX] again.
- **To play a specific demo**, hold down [MIX] and press any of the five number buttons from [0] through [4]. After a brief pause playback will start with the demo you've selected, then continue through the remaining demos until done.

*Note: After any of the demos stop playing, the QS will automatically return itself to Program Mode. The next time you enter Mix Mode you will probably see the name of the demo which was last played. This is because the Mix which was used for the*

*demo sequence remained in the Mix Mode edit buffers, which is normal. To clear this, call up another Mix.*



## PLAYING PROGRAMS

The mode in which your QS plays Programs is called, logically enough, *Program Mode*. To enter it at any time, just press the [PROGRAM] button on the front panel.

Once there, all you have to do is play.

To explore different Programs in the current Bank, use the [SELECTION] and [VALUE] buttons. Experiment with them until you have a feel for how they work.

Remember that the [VALUE] buttons move through the available Programs one at a time, while the [SELECTION] buttons enable you to jump around at will — to get Program 27 you would push [20] and then [7], to get Program 99 you would press [90] and then [9], and so forth.

*Please note: In MIDI there are no Program numbers above 127, so pressing [8] or [9] after pressing [120] won't do anything; and pressing [120] from any Program number ending in 8 or 9 will "wall out" your Program choice at Program #127.*

To explore Programs in a different Bank, use the [BANK] buttons. You can also get to a new Bank by using the [VALUE] buttons to scroll from the end of one Bank to the beginning of another, or vice-versa. (This means that if you are at Program 127 in the **Preset1** Bank, and press [▲ VALUE], you will jump to Program 00 in the **Preset 2** Bank.)

The number, name, and Bank of the current Program will be visible in the LCD display, which should look something like this:

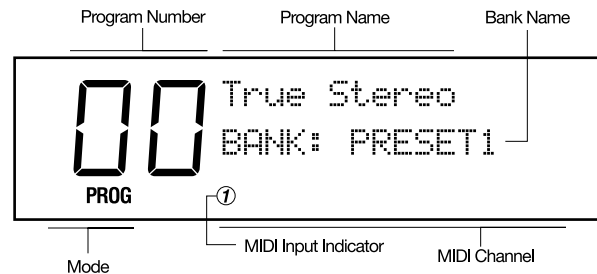

- The big numerals on the left show you the number of the current Program.
- The upper line spells out the current Program's name.
- The middle line identifies the current Bank.
- The **PROG** beneath the Program Number shows you are in Program Mode.
- The small number underneath the Bank listing shows the current MIDI channel. It is also a MIDI activity indicator, flashing a small circle whenever MIDI data is sent or received over this channel. (To see this for yourself, hit any key.)

## CHANGING THE MIDI CHANNEL

MIDI has 16 channels. While in Program Mode, your QS can transmit and receive information on only one of them. As noted just above, the current channel is shown by a small indicator along the bottom of the LCD display.

To change this MIDI channel setting, press either of the the [PAGE] buttons on the front panel until the MIDI channel number you want is visible in the display.

## PLAYING MIXES

In Program Mode you play Programs, so to play Mixes you can probably guess that you'd have to be in *Mix Mode*. To enter this mode at any time, just press the [MIX] button on the front panel.

The display should look something like this:

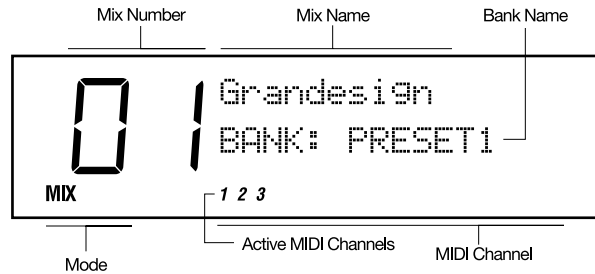

As you can see, there are only two visible differences between this and the Program Mode display:

- **The mode indicator in the lower left of the display reads MIX.**
- **More than one MIDI channel is indicated.** The numbers you see here tell you what MIDI channels are being used to send and/or receive in this Mix. (This also gives you a quick way of seeing how many Programs are in a particular Mix, since the nature of Mixes is to have one Program per enabled MIDI channel.)

## PICKING A MIX BANK

Mixes come in Banks, just like Programs. In fact, they come in exactly the same Banks — the only difference is that there are 100 Mixes in each Bank, as opposed to 128 Programs.

To cycle through the available Banks, get into Mix Mode and press the [BANK] buttons as described earlier.

## SELECTING MIXES

This works as described earlier for Programs; you're just in a different Mode when you do it. Start by making sure you are in Mix Mode, then use the [VALUE] keys and [SELECTION] buttons to call up the Mix of your choice.

*Please note that there are only 100 Mixes (numbered 00 through 99) in each Bank. This is why pressing the [100], [110], and [120] selection buttons while you are in Mix Mode won't have any effect.*

## FINDING OUT WHAT PROGRAMS ARE IN THE MIX YOU ARE PLAYING

It's easy to see what Programs are currently assigned to the active MIDI channels in a Mix. Just enter Mix Mode, call up the Mix you want to examine, and then move through its MIDI channels using the [PAGE] buttons. Do that and the display will change to look something like this:

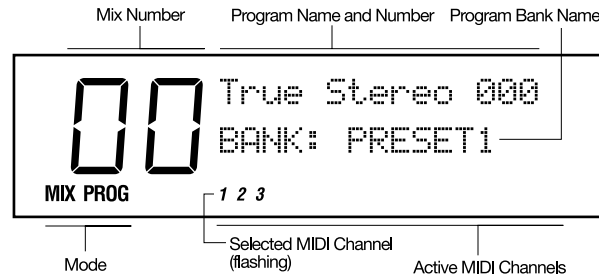

There are five differences between this and the normal Mix Mode display:

- **The upper line shows the Program assigned to the current MIDI channel.** This name always appears inside quotation marks, so you can tell at a glance that you are not in standard Mix Mode.
- **The upper line shows this Program's number.**
- **The middle line shows the Bank that the identified Program belongs to,** instead of the Bank that the Mix is in. As you will see when you examine enough different Mixes, Programs can come from any Bank at all. You aren't limited to working just from those within the same Bank as your Mix. This is wonderfully useful, but has some wrinkles you'll need to be aware of if you ever create Mixes using Programs stored on Expansion cards. (We'll cover those issues in more detail in *Part 4: Basic Operation.*, *Part 7: Editing Mixes*, and *Part 9: Extras.*)
- **The mode indicator beneath the Program Number now reads MIXPROG.**
- **The current MIDI Channel Number will be flashing.**

You can also *change* Program assignments from this display, but don't try that just yet. We'll cover that fully in the next section, *Part 4: Basic Operation.*

Don't be confused by the fact that you can use the [PAGE] buttons to look at all 16 MIDI channels in a Mix, even if those channels aren't actually enabled. The only channels that matter are the ones whose numbers are visible across the bottom of the display when you first call up the Mix.

And now, just for fun...

## THE PERFORMANCE CONTROLS, PT. II

We described these real-time controllers in *Part 2: Overview*. Now that you know how to find your way to all the different Programs and Mixes, it's time to explore just what the controllers can do.

Your assignment: Call up a Program or a Mix and try out the items listed just below. When you think you've got a sense of how they work (or don't) with your current choice, call up a different Program or Mix and try them again. As you move around you'll see some interesting variations!

Here 's the list, as a reminder.

- **Velocity.**
- **Aftertouch.**
- **Pitch Bend Wheel.**
- **Modulation Wheel.**
- **Controller A–D Sliders.**
- **Sustain Pedal.**
- **Expression Pedals.**

## TRANSPOSING THE KEYBOARD

One of the great conveniences of electronic keyboards is how easily they can be transposed, allowing you to play all possible keys (even the more difficult ones) without having to learn as many different fingerings and hand positions.

Just to round things out before we move on, why not experiment with your QS's Performance Transpose feature?

All you have to do is:

- 1) Hold down the [TRANPOSE] button.
- 2) Tap the key that represents the interval you'd like to shift by. If you want to shift up a semitone, for example, you would tap **any** C-sharp on the keyboard that lies above Middle C. And if you want to shift a major third down, you'd press any G-sharp **below** Middle C. *See the chart on the next page for further guidance.*
- 3) Now let go of the [TRANPOSE] button.

It's that simple. Try it and see for yourself. When you finally want to return things to normal, just hold down [TRANPOSE] again and tap on the MIDDLE C key before letting go.

You can go up or down as much as an octave, giving you a total of two octaves of transposition range.

*This technique gives you a quick way to make transpositions "on the fly." You can also transpose your QS using one of the Global commands. That works just a little differently, and will be covered in the next part of this manual.*

## PERFORMANCE TRANSPOSITION CHART

<b>UP</b>			
	OCTAVE	+ 12 semitones	C above Middle C
	MAJOR SEVENTH	+ 11 semitones	B above Middle C
	MINOR SEVENTH	+ 10 semitones	B-flat above Middle C
	MAJOR SIXTH	+ 09 semitones	A above Middle C
	MINOR SIXTH	+ 08 semitones	G# above Middle C
	PERFECT FIFTH	+ 07 semitones	G above Middle C
	DIMINISHED FIFTH	+ 06 semitones	F# above Middle C
	PERFECT FOURTH	+ 05 semitones	F above Middle C
	MAJOR THIRD	+ 04 semitones	E above Middle C
	MINOR THIRD	+ 03 semitones	D# above Middle C
	MAJOR SECOND	+ 02 semitones	D above Middle C
	MINOR SECOND	+ 01 semitone	C# above Middle C
<b>NORMAL</b>			<b>Middle C</b>
	MINOR SECOND	- 01 semitone	B below Middle C
	MAJOR SECOND	- 02 semitones	B-flat below Middle C
	MINOR THIRD	- 03 semitones	A below Middle C
	MAJOR THIRD	- 04 semitones	G# below Middle C
	PERFECT FOURTH	- 05 semitones	G below Middle C
	DIMINISHED FIFTH	- 06 semitones	F# below Middle C
	PERFECT FIFTH	- 07 semitones	F below Middle C
	MINOR SIXTH	- 08 semitones	E below Middle C
	MAJOR SIXTH	- 09 semitones	D# below Middle C
	MINOR SEVENTH	- 10 semitones	D below Middle C
	MAJOR SEVENTH	- 11 semitones	C# below Middle C
	OCTAVE	- 12 semitones	C below Middle C
<b>DOWN</b>			

**PART 4****BASIC OPERATION****RECAP**

At this point you've pretty much learned everything there is to know about how to play your QS7.1/QS8.1:

- You've got it hooked up and amplified.
- You know about Banks, and how to switch among them.
- You know about Programs and Mixes, and how to call them up.
- You know how to use the real-time performance controllers.
- You know about the various types of PCMCIA expansion cards, and how to plug them in as sources for additional Banks of Programs and Mixes.

That's quite a lot, actually. Add in a few more basics and some MIDI info (see *Part 5: MIDI*) and those of you who aren't interested in editing anything in your instrument will be set.

Ready? In this section of the manual we'll give you those remaining non-MIDI basics. They include copying Programs and Mixes to new locations in the User Bank (or a Card Bank), renaming copied Programs and Mixes, changing the Programs assigned to a Mix, playing Sequences from memory cards, and everything you need to know about your QS's Global settings.

But before we get started, there's something we think you ought to know:

**THE DOUBLE-BUTTON PRESS TRICK**

There's a pretty nifty hidden trick in the QS's operating system. It's called the "Double-button press", and what it does is reset certain parameters or functions back to a certain value without you having to actually push those same buttons a bunch of times to get there. It works with the [VALUE] buttons, the [PAGE] buttons, and the [BANK] buttons.

Here are the areas where this trick is useful:

- If you press both [VALUE] buttons at the same time while you're in one of the Edit Modes (Program, Mix, Effects or Global), the value which is currently displayed will change to the factory default for that parameter. This works in Store Mode, too!
- If you press both [PAGE] buttons at the same time while you're in one of the Edit Modes, the Page which is currently displayed will change to the first page in whatever Function you're working with. This one also works in Store Mode.
- If you press both [PAGE] buttons at the same time while you're in Mix Program Select mode or Program Play mode, the QS will jump to MIDI channel 1.

- If you press both [BANK] buttons while you're in Mix Play or Program Play modes, the QS will jump to the same location in the User bank.

## COPYING EXISTING PROGRAMS AND MIXES TO A NEW LOCATION IN THE USER BANK

You can readily move copies of existing Programs and Mixes into the User Bank. This is useful if you want to put them in a certain order for recording or performance, or to arrange interesting starter materials in preparation for editing.

The procedure is an easy one.

- 1) Press [STORE]. The display will look something like this:

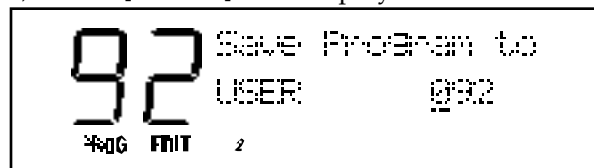

- 2) Using the [VALUE] buttons or the [EDIT VALUE] slider — also known as [CONTROLLER D] — pick a User Bank location between **000 and 127** (**00 and 99** in the case of Mixes). You can also directly enter the number you want using the 23 [SELECTION] buttons.
- 3) Press [STORE] again, and you're done.

## ...OR TO A NEW LOCATION ON A CARD BANK

If you have an SRAM card, you can move a Program or Mix to any one of the banks on the card. The procedure is the same as listed above for copying a single Program or Mix to the User Bank, except that in step 2) you would use the [BANK] buttons to select a Card bank as your destination instead of the User bank. Everything else works the same.

*For more about working with SRAM cards, see Part 9: EXTRAS.*



## CHANGING THE PROGRAMS IN A MIX

This is actually the first level of editing for Mixes, but that's okay — it's an easy and useful thing that you can do whenever you are in Mix Mode...and best of all you don't need to know anything special to do it!

- 1) Get into Mix Mode by pressing the [MIX] button.
- 2) Press either of the [PAGE] buttons and look at the display. One of the MIDI channel indicators on the bottom line should be flashing, and the upper line should now show a Program Name and Number. This Program is the one currently associated with the flashing MIDI channel.
- 3) Use either the [VALUE] buttons or any of the 23 [SELECTION] buttons to call up a different Program. You can also call up Programs from other Banks by using the [BANK] buttons. The upper line of the display will change to show you which Program you've selected for that MIDI channel.
- 4) Do this until you like what you've got.
- 5) If you want to change Program assignments for another MIDI channel, use the two [PAGE] buttons to move around among the 16 channels that are available.

To stop editing and return to normal operation, press either [MIX] to go to Mix Mode, or [PROGRAM] to return to Program Mode.

*Note: Your QS will let you change Program assignments on all 16 MIDI channels, even ones that aren't yet enabled in this Mix. You won't hear the changes you make to a channel that isn't yet enabled. That's all right. If you want you can always go ahead and make the assignments you want now, and enable their MIDI channels later.*

## STORING ALTERED MIXES TO THE USER BANK (OR TO A CARD)

This works just like copying, which was described a little earlier. A recap: Once you've come up with a new combination of Programs that you like, press [STORE] while still in Mix Edit Mode. Select your target bank and any number between 00 and 99 (using the usual methods), then press [STORE] again and you're done.

## STORING ALTERED PROGRAMS TO THE USER BANK (OR TO A CARD)

This works just like copying, which was described a little earlier. A recap: Once you've come up with a new combination of Sounds that you like, press [STORE] while still in Program Edit Mode. Select your target bank and any number between 000 and 127 (using the usual methods), then press [STORE] again and you're done.

## CHANGING THE NAME OF A PROGRAM OR MIX

Call up the Program or Mix whose name you wish to change. Make sure it is visible in the display, and then:

- 1) Press [EDIT SELECT].
- 2) Press [120], which calls up the NAME function while editing. The name you wish to edit will appear, inside quotation marks, in the middle line of the display. One of the characters in the name will be underlined (probably the first one, if this is your first time naming something). Pressing both [PAGE] buttons at the same time will take the cursor back to the first character, if that's the one you want to change.
- 3) Change the underlined letter by moving the [EDIT VALUE] slider or pressing the [VALUE] buttons.
- 4) Move the cursor back and forth among the available spaces by pressing the [PAGE] buttons. Change any or all of the characters as you wish.
- 5) When you are done — there is a 10-character limit — go through the steps described above to store the newly named Program or Mix somewhere. Then press either [PROGRAM] or [MIX] to leave this mode.

## COMPARE MODE

The [◀BANK] button doubles as the [COMPARE] button (note the silkscreening on the panel under the button). It allows you to go back and forth between the edited version and the original version of a Program or Mix before committing yourself to storing it.

Once a Program or a Mix have been edited, the word "EDIT" will change to "EDITED" in the lower-left corner of the display. If [COMPARE] is pressed while in an Edit Mode, you'll see the word "EDIT" start flashing. If you play the QS while it is doing this, you will temporarily be hearing (and seeing) the original version of the Mix/Program. If you are editing a Mix and press [COMPARE], the original unedited Mix is temporarily recalled. Likewise, if you are editing a Program or its Effects Patch and press [COMPARE], the original Program will be temporarily recalled. Pressing [COMPARE] again switches back to the edited version, and the word "EDIT" will revert back to "EDITED" in the display.

## PLAYING SEQUENCES FROM A CARD

[This section assumes that you have some PCMCIA Expansion Cards with sequences on them. If you don't, you can move on and come back to this section later.]

Several of the Alesis QCards come with their own demonstration sequences. More importantly, you can store your own MIDI sequences to RAMcards (in Standard MIDI File format) using a computer and Alesis's free Sound Bridge software, and then play them back easily from your QS.

Here's all you have to do.

- 1) Insert the RAMcard containing sequence data into either of the two [PCMCIA EXPANSION] slots on the back panel of your QS.
- 2) Press the [SEQUENCE] button. The display will look like this:

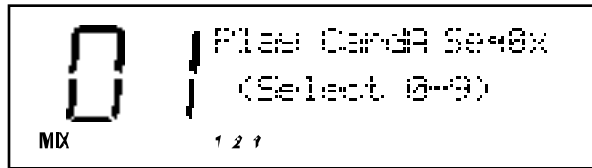

- 3) Use the [SELECTION] buttons to pick the Card and Sequence Bank that holds the sequence you'd like to play: the [00] through [40] buttons select Sequence Banks 0-4 on Card A, while [50] through [90] select the equivalent Sequence Banks on Card B.
- 4) Finally, use the [0] through [9] buttons to activate a specific sequence from the selected Sequence Bank (each Bank can hold 10 sequences).

If there is a sequence there, just wait a moment and it will play. (A blinking right arrow will show up in the display during playback.) If there isn't a sequence there, then the display will tell you so.

To stop a sequence while it's playing, you can press your choice of the [SEQUENCE], [PROGRAM] or [MIX] buttons. To leave this Mode and return to where you started without triggering a sequence, press [SEQUENCE] again.

# THE GLOBAL SETTINGS (AND HOW TO CHANGE THEM)

Certain basic parameters affect your entire QS. Because they affect everything, they are called the *Global* Settings. There are 19 of them:

01	Master Pitch
02	Master Tune
03	Keyboard Velocity Curve
04	Keyboard Velocity Scaling
05	Transpose
06	Keyboard Mode
07	General MIDI
08	Controller A #
09	Controller B #
10	Controller C #
11	Controller D #
12	Pedal1 Control #
13	Pedal2 Control #
14	MIDI Program Change Mode
15	Input/Output Mode
16	MIDI Out Mode
17	Reset Controllers A-D
18	Controller A-D Mode
19	Clock Source/Rate

## EDITING GLOBAL PARAMETERS

To enter Global Edit Mode:

- 1) Press [EDIT SELECT].
- 2) Press the [BANK ►] button (that's the one that has GLOBAL written beneath it). The display will look like this:

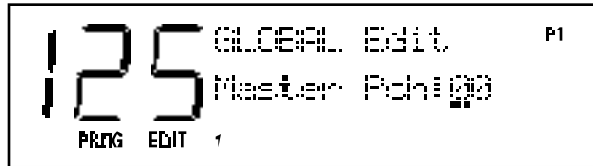

Now look in the upper right corner of the display. There you will see an indicator that says P1. This stands for *Page One*, and it tells you where you are among the 19 possible Global parameters. (Naturally enough, since there are 19 parameters there are also 19 separate pages.)

- **To move around inside Global Edit Mode**, you'll use the [◀PAGE] and [PAGE▶] buttons. These cycle you through all the available pages and their associated parameters. (Try it and you'll see that the page indicator changes as you go.)
- **To change the settings you see in the Global Edit pages**, use either the [D] slider (the one with EDIT VALUE written under it) or the two [VALUE] buttons.
- **To leave Global Edit Mode**, press either [MIX] (to return to Mix Mode) or [PROGRAM] (to return to Program Mode).

*You can also shift directly from setting Global parameters to editing either Programs or Mixes by pressing one of the 23 [SELECTION] buttons. But that's for later in this manual. Right now, we want to stick to Global changes only.*

### PAGE 1 — MASTER PITCH

As you can probably guess from its name, this setting controls the Master Pitch of your QS. Adjust this parameter when you wish to globally transpose all sounds played by the QS, whether from the keyboard or by incoming MIDI information.

This parameter does not change the pitch of drum sounds (but see note below). It also has no effect on the Range settings in Mixes and Programs, or on what note data gets sent from the QS's MIDI Out when you play the keyboard.

The range for this setting is **-12 to 12**, which is equivalent to down or up by one octave (in semitones).

*Note: Changing MASTER PITCH can alter QS drumkits in unpredictable ways, because it shifts the key assignments of multi-sampled drumkits in Keyboard Mode but doesn't shift Drum Mode sounds. Most Preset drumkits are constructed using a combination of the two. (For an explanation of Drum Mode, see Part 8: EDITING PROGRAMS.) This goes for incoming MIDI notes as well as notes played on the keyboard, so your drum parts will play back differently than you laid them down if you alter Master Pitch after recording. If you want to explore these changes, go ahead — you can always return things to normal by setting MASTER PITCH back to 00.*

## PAGE 2 — MASTER TUNE

This setting is like Master Pitch, but on a much finer scale. Its main use will be to tune your QS to match other instruments. (If you are playing along with an acoustic piano that is consistently a little sharp or flat, for example, it's a lot easier to tweak this setting than to call in a piano tuner!)

Like Master Pitch, Master Tune has no effect on Drum Mode sounds, Range settings, or the note data sent from the instrument's MIDI Out. But it does affect multi-sampled drumkits from Keyboard Mode (see note).

The range for this setting is **-99 to 99**. This is equivalent to down or up one half-step (in hundredths of a semitone).

*Note: Drumkit time again. This parameter does not have any effect on Drum Mode sounds. However, it will work to tune drums that are part of multisampled Keyboard Mode drumkits. What happens is that they tune down or up as far as they can go and then switch to the next keygroup, which will probably be a different sample.*

## PAGE 3 — KEYBOARD VELOCITY CURVE

This parameter alters the “feel” of your QS's keyboard playing response. There are three options:

**WEIGHTED** gives the keyboard the widest possible dynamic range.

**PLASTIC** has the narrower dynamic range associated with typical synth keyboards. You can still hit maximum volume with this setting, but notes played gently will be louder than they would be if you had selected **WEIGHTED**. Use this mode when you want a smoother, flatter keyboard response.

**MAXIMUM** means that every note played on the keyboard is given the maximum MIDI velocity, which is 127. In this mode, your QS's keyboard is no longer velocity-sensitive. (Please note that while this affects the keyboard and any note data being sent *from* your QS, it has no impact on how incoming MIDI note data is processed. Altering that is done on a Program by Program basis, using the Velocity Curve parameter available in Program Edit Mode.)

## PAGE 4 — KEYBOARD VELOCITY SCALING

This parameter also alters the “feel” of your QS's keyboard, but in a different way than the Keyboard Velocity Curve setting mentioned just above. Unlike that setting, it doesn't alter the dynamic range. Instead it takes the existing velocity curve and gives it a slight bias toward either soft or hard styles of playing.

Here's how it works. The range for this setting is **00 to 99**. When set to 00, it scales the keyboard velocity data so that loudness increases more slowly than usual as you play harder. At 00 it is a little easier to play quietly and a little harder to play loud. Push this setting all the way up to 99 and you get the opposite: keyboard velocity is scaled to make it easier to play loud, while playing soft will require great finesse.

The factory default setting is 65, which gives an even scaling that favors neither loud nor soft playing. You will need to experiment with this parameter to find exactly the right adjustment for your own “touch.”

## **PAGE 5 — TRANSPOSE**

This is the same Transpose setting you were introduced to in *Part 3: First Session*. The only difference is that in Global Edit Mode you make changes using the standard [EDIT VALUE] slider and [VALUE] buttons, not by pressing keys on the keyboard.

The transposition range is from **-12 to 12**, which is the same as moving down or up by semitones over a two-octave range. It works by changing the MIDI Note Numbers assigned to the keyboard, thus changing the note data sent out from your QS when you play.

So, if you want to play notes that are outside the QS’s normal 61-note range (MIDI Note Numbers 36-96), then by all means transpose! Taken down an octave, the keyboard’s range becomes MIDI Note Numbers 24-84; taken up an octave, it covers MIDI Note Numbers 48-108.

This is very useful knowledge if you are using your QS to play music into a sequencer, since this parameter gives you two extra octaves of keyboard recording range.

## **PAGE 6 — KEYBOARD MODE**

There are three possible keyboard modes. Which one you want to use will depend on how you are using your QS:

**NORMAL** is the default setting. When NORMAL is selected, Program Mode receives and transmits over the MIDI channel indicated in the display. In Mix Mode, MIDI information is received over all active MIDI channels, but sent only from those displayed channels that have had MIDI OUT enabled. The MIDI Channel indicators in the lower line of the display will show which channels are active at any given time.

**CH SOLO** changes the way the keyboard handles MIDI in Mix Mode (it has no effect on Program Mode). The simplest way to describe what it does is to say that it isolates individual channels in a Mix, allowing you to play *only* the selected channel (indicated by a flashing number in the display) from the keyboard, while ignoring all the Programs assigned to other channels. This is a great way, for example, to individually check out the different Programs that are in a layered Mix. And since CH SOLO has no effect on incoming MIDI data, it’s a great mode for sequencing. You can just move through your multi-timbral Mix one channel at a time, recording on single channels as you go while always hearing playback on everything that you’ve already laid down. (If you’ve selected CH SOLO, the [◀PAGE] and [PAGE▶] buttons are what you’d use in Mix Mode to hear each channel in turn.) When using CH SOLO, make sure you turn off your sequencer’s ECHO function (sometimes called SOFT THRU or THRU). More about this sort of thing in *Part 5: MIDI*.

*Note: This mode is automatically selected by the QS when the General MIDI function is set to ON.*

**OUT 01 through OUT 16** select a single MIDI channel to transmit on, while simultaneously shutting off local keyboard control. You'll want to choose this setting if you are using a sequencer that automatically echoes back the MIDI data that is being recorded. (If your sequencer works that way and you don't choose one of the OUT settings, you will run out of available Voices faster as the echoed notes double what you are playing.)



*Setting the Keyboard Mode to one of the OUT values is the QS's equivalent to LOCAL OFF.*

## **PAGE 7 — GENERAL MIDI**

This parameter turns General MIDI Mode on and off. You'll want to set it to ON if you are going to use your QS to play back sequences created specifically for use with a General MIDI module. Otherwise you'll want to leave it alone.

For more information about General MIDI, see the MIDI supplement in *Part 10: Appendices*.

**WARNING:** Do not change this setting to ON unless you really mean to. Why? Because doing so will immediately take you out of Global Edit Mode, switch to Mix Mode, and call up the GM Multi Mix (Mix 00 in Preset Bank 4, which is the General MIDI Bank). This can be pretty darned confusing if you aren't expecting it, but don't worry — it's easy to return to Global Edit Mode and set this parameter back to OFF.

Some (but not all) General MIDI sequences will have a SysEx message at the beginning which tells the receiving device to go into General MIDI mode. The QS will respond to such a message. If one comes in, then your instrument will immediately jump from wherever it is to the GM Multi Mix.

*The General MIDI spec reserves MIDI Channel 10 for drumkits. Because of this, when the global General MIDI setting is ON, your QS won't be able to call up anything but drumkits on Channel 10 (from the front panel or via MIDI).*

*Note: Turning General MIDI mode ON also automatically sets your Keyboard Mode to CH SOLO. Turning General MIDI off will put the Keyboard Mode back the way it was. Also, see the Note under Global Page 14.*

## **PAGE 8 — CONTROLLER A #**

This parameter lets you select the MIDI Controller Number that will be assigned to the front panel's [CONTROLLER A] slider. This is useful both for controlling external MIDI devices and for giving you sequencer-recordable control over a variety of Program and Effect parameters. The factory default is Controller 012.

For a listing of all MIDI controllers and their designations, see the MIDI Supplement section of *Part 10: Appendices*.

## **PAGE 9 — CONTROLLER B #**



The same as Global Edit Page 8, above, but for Controller B. The factory default is Controller 013.

---

## **PAGE 10 — CONTROLLER C #**

The same as Global Edit Page 8, above, but for Controller C. The factory default is Controller 091.

## **PAGE 11 — CONTROLLER D #**

The same as Global Edit Page 8, above, but for Controller D. The factory default is Controller 093.

## **PAGE 12 — PEDAL 1 CONTROL #**

Just like MIDI Controllers A–D, your QS's [PEDAL 1] jack can be assigned to a MIDI controller. In fact, it already is. The factory default is Controller 007 (Main Volume), which explains why a pedal plugged into the back panel's Pedal 1 jack will automatically control volume.

It doesn't have to be limited to that, however. You can use this parameter to change it to any Controller from 0 to 120. (Please note that if you do, a footpedal plugged into your [PEDAL 1] jack won't work as a volume control anymore!)

In short, then, this setting determines what MIDI data is sent out when you step on a properly-connected footpedal. And since PEDAL 1 is also an available setting for modulating Programs or Effects, your choice here will determine exactly what incoming MIDI Controller data will modulate those Programs, Effects and (by extension) Mixes that have been set up to respond to PEDAL 1.

Something to be aware of: Unless you deliberately mean to, don't assign the same Controller Number to two different physical controllers. Their interaction could get very confusing! It's even possible that they could fool you into thinking that something in your QS is either broken or not working properly, since you'd be moving a controller and not getting the exact response you expect.

## **PAGE 13 — PEDAL 2 CONTROL #**

This setting works exactly like Pedal 1, just above.

If you don't have a second pedal, you can still use this function in a very powerful way. This Global page gives you one more assignable continuous controller to which the QS can respond. Also, when you get to *Part 8: Editing Programs*, you will see that PEDAL 2 is one of the available Program modulation sources. So you can plug in a second pedal and control any number of Program or Effects modulation destinations, or you can simply allow the MIDI controller of your choice to do it for you.

The factory default for this setting is 004 (Foot Controller).

## PAGE 14 — MIDI PROGRAM SELECT MODE

This parameter determines how your QS deals with MIDI Program Change Commands. There are three possible settings:

**OFF** turns all Program Changes off. With this choice selected, your QS will neither send Program Changes nor respond to them.

**ON** makes the QS respond to incoming MIDI Program Changes, and send them out whenever you change Programs from its front panel. In Program Mode it will send and receive Program Changes over the currently selected MIDI channel. In Mix Mode, Program Changes are received over all active MIDI channels, but sent only from those displayed channels that have had MIDI OUT enabled. Please Note: With this setting, incoming Program Changes will only affect the Programs associated with each specific channel, not the entire Mix.

**MIDI MIX SELECTION: CHANNEL 1 through CHANNEL 16** are identical to ON as far as Program Mode is concerned. In Mix mode they work quite differently, however, allowing you to change entire Mixes in response to Program Change commands. Select CHANNEL 4, for example, and a Program Change 22 command coming in over MIDI Channel 4 would automatically select Mix 22 in the current Bank. The same is true of Bank Select messages which come in on Channel 4 in this scenario; they'll call up a Mix in another Bank. (Program Changes coming in over other MIDI channels would continue to work as before, changing any Programs associated with those channels within the current Mix.)

*Any time you turn General MIDI Mode (Global Page #7) to ON, the MIDI Program Change setting will automatically default to ON as well. There's a good reason for this: if MIDI MIX SELECTION were left in place here, then an incoming Program Change could call up some other Mix than the standard GM Multi Mix...and there'd be no telling what the GM sequence you were playing might wind up sounding like!*

For an in-depth discussion of how these settings impact Bank Select transmission and response, see *Part 5: MIDI*.

## PAGE 15 — INPUT/OUTPUT MODE

This parameter determines whether your QS will communicate to the outside world through (A) its MIDI jacks, or (B) its serial port. The possible selections depend on how the rear panel [SERIAL PORT SWITCH] is set.

- 1) If the switch is set to MAC, your choices will be MIDI and MAC 1MHz.
- 2) If it is set to PC, your choices will be MIDI, PC 38.4kBaud, and PC 31.25kBaud. (Your typical PC will work properly at the 38.4kBaud setting. PCs that require the 31.25kBaud setting are quite rare.)

If you select MIDI, then the MIDI jacks will work and the serial port won't. This is the factory default.

Select any of the others and you'll get the opposite result: the serial port will be on and the [MIDI IN] and [MIDI OUT] jacks will be shut off (although the MIDI OUT jack can still be used as a MIDI THRU depending on the MIDI Out Mode setting described just below).

## PAGE 16 — MIDI OUT MODE

In normal MIDI operation, this parameter lets you switch the function of the back panel [MIDI OUT] jack between being a MIDI OUT and being a MIDI THRU. Given that, the two possible settings — OUT and THRU — should be self-explanatory. The factory default is OUT.

If, however, you have selected one of the SERIAL PORT settings instead of MIDI (as discussed just above) then your choices become OFF and THRU, with **OFF** as the default.

When this setting is OFF, the [MIDI OUT] jack doesn't send any data to external devices. Change it to THRU and the jack will automatically echo any MIDI data coming into your QS over the serial connection.

*In some situations you may need a direct serial link to a computer and a normal MIDI OUT running from your QS to other instruments. Here's the solution: Set the MIDI Out Mode to THRU and then turn on your computer's MIDI THRU function. This will echo any incoming QS data back to your keyboard, which will echo it in turn to the [MIDI OUT] jack that is operating as a MIDI THRU. The net result will be the same as if a normal MIDI OUT was in place.*

## PAGE 17 — RESET CONTROLLERS A-D

This parameter determines whether the values for Controllers A–D will (A) reset to zero or (B) stay the same whenever a new Program or Mix is chosen. The factory default is **ON**, which is the setting that forces a reset whenever you change from one Program or Mix to another. The other possible setting is **OFF**.

Which one makes the most sense will depend on what you are trying to do.

For example:

If you were using [CONTROLLER] sliders to affect the volumes of external MIDI sound modules, you'd probably want to set this parameter to OFF. That way you wouldn't reset all the different modules to zero volume every time you changed Programs.

On the other hand, if you were using the [CONTROLLER] sliders to modulate various Program parameters, then you might very well want to set this parameter at ON in order to maintain a smooth continuity of control as you move among different Programs and Mixes.

## PAGE 18 — CONTROLLER A-D MODE

This parameter determines how the data generated by moving Controllers A–D will be used. There are three possible settings:

**LOCAL** sets things so that your [CONTROLLER] sliders work with your own QS, but do *not* generate any MIDI data.

**MIDI** does the exact opposite. Select this, and your [CONTROLLER] sliders will send out MIDI data but have no effect on your own QS Programs and Mixes.

**BOTH** sets the sliders up so they control your QS *and* send MIDI data. This is the factory default setting.

## **PAGE 19 — CLOCK SOURCE/CLOCK RATE**

This parameter determines the “sample playback rate” which the QS will use. If you’re not using the QS’s digital audio output to send the signal from your QS to some other piece of gear, you should leave this parameter alone.

But if you are using the digital audio output capability of the QS, then you will find this page of the Global Edit Mode to be very useful. There are four different settings here: **Int 48kHz** (the default), **Int 44.1k**, **Ext 48kHz** and **Ext 44.1k**.

The concept of a “clock rate” is based upon the fact that every sound inside the QS is a digital recording of something. What a digital recording does is take a bunch of “snapshots” of an audio signal. These “snapshots” are then played back in order to reconstruct the original sound. The process is something like the relationship between one frame from a videotape and the “playing back in order” of a bunch of video frames in order to “recreate” the original scene.

And in the same way that the video frames blend together to create the perception of motion, so the audio samples in the QS are played back so quickly and so seamlessly that they appear to the human ear to be one sound. The rate at which samples are played back is determined by the Clock function.

When set to either Internal setting, the QS uses its own internal sample clock as a reference for playing back the sampled sounds in your Program or Mix. But in a digital recording environment, it is often necessary for a piece or several pieces of gear to be able to “turn over control” to one “master” clock signal, so that all of the gear can play back their “snapshots” at the same rate.

Hence the “External” clock settings of the QS. Note that if you set the QS to one of the two External clock settings without hooking it up to an external clock, it will make a sort of “hissing” or “sprinkler” noise. This is because it is looking for something to provide it with a clock signal and it isn’t finding it.

So here’s a brief rundown on when to use which setting:

**Int48kHz.** This is the default setting for the internal clock. It will have an almost imperceptibly wider frequency response than 44.1 kHz. Use it if recording via the QS’s digital output to an ADAT-XT which is using a sample rate of 48 kHz and there is no Alesis BRC in the system.

**Int44.1k.** The one to choose if you are recording digitally to an ADAT-XT which is using a sample rate of 44.1 kHz and there is no Alesis BRC in the system.

**Ext48kHz.** If you are recording to an ADAT-XT in the digital domain and are using an Alesis BRC, connect a BNC-to-BNC cable between the BRC’s 48 kHz Clock Out and the QS’s [48 kHz IN]. Then select the Ext48kHz setting for the QS’s clock setting.

**Ext44.1k.** Same as above, but if the BRC has been set to 44.1 kHz (by having been “Pitched Down” to -147), select the Ext44.1k clock setting for the QS.

If you would like a visual aid for this, check out the Connection diagrams in *Chapter 1: Setups and Connections*.

## PART 5

# MIDI

## WHAT WE'LL COVER HERE...

- **Sequencing with the QS7.1/QS8.1 via MIDI or the serial port.**
- **Using the QS as a master MIDI keyboard for a live rig,** along with a little more info about controlling external MIDI devices from a Card sequence.
- **Sys-ex transfers.** How to go about transferring single Programs, Mixes or an entire User bank via Sys-ex to a computer or another QS series synth.

## ...AND WHAT WE WON'T (BUT WHERE YOU CAN FIND IT).

- **How to create a Mix.** We will go over selecting Programs within a Mix (the very top level of Mix editing), but for information on things like setting levels or selecting the Effects Patch within the Mix, see *Part 7: Editing Mixes*. Our main focus here will be on interfacing the QS with the outside world.
- **General MIDI (GM)** will only receive a brief amount of coverage here, because it's covered pretty well in the discussion about Global Edit Mode's page 7 (Part 4: Basic Operation). There's even more in-depth coverage of it in Part 10: Appendices (Appendix B: MIDI Supplement).
- **Basic MIDI concepts.** If you're a novice to the world of MIDI, you should make it a point to read the MIDI Supplement in Appendix B soon. It'll help things make a lot more sense a lot sooner if you want to get a good handle on MIDI sequencing.

## THE POWER OF MIX MODE

In Program Mode, the QS sends and receives MIDI information on only one MIDI channel at a time. In Mix Mode, however, the QS can send and receive on as many as 16 MIDI channels at once, each with its own keyboard range and a whole lot of other parameters you can customize. Mix Mode allows a single QS to play back full song arrangements at one time, with full control over the levels and stereo placement of the various Programs, complete with the Effects necessary to make the music shine.

But we also said it *cansend* (and how!). A QS in Mix Mode gives you the potential to control a whole lot of other MIDI devices at one time. When the next song calls for you to layer strings from *that* box with the brass from *this* box along with a couple of internal Programs, mixed just so, while calling up the DMPPro kit for the drummer, setting the Q20 Reverb patch for the singer, and changing the setup on your lighting controller, selecting a single Mix on the QS can do all of that. It'll set up your whole rig instantly, right before the next song is to begin (even if your band changes its collective mind at the last second and starts a tune that wasn't on the song list!).

We'll dig into the MIDI controller aspects of the QS later in this chapter. For now, let's start talking about...

## USING AN EXTERNAL SEQUENCER

The QS can generate MIDI signals for a sequencer to record. On playback, the sequencer sends this data back into the QS, which then serves as a multitimbral sound module (in Mix Mode). The sequencer can generate data over several channels; in Mix Mode, the QS can be programmed so that individual Programs play sequenced data on specific channels. *Example:* If the sequencer transmits a piano part over channel 1, a bass part over channel 2, and a drum part over channel 10, you could set up a QS Mix so that a piano sound plays only the MIDI data coming in on channel 1, a bass sound plays only the MIDI data coming in on channel 2, and drums play only the MIDI data coming in on channel 10.

For this to happen, you have to connect the sequencer's MIDI Out to the QS's [MIDI IN], and the QS's [MIDI OUT] to the sequencer's MIDI In. Also, in Global Edit mode, page 15 (I/O) must be set to "MIDI". This allows the QS to send data to the sequencer for recording, and play back data from the sequencer.

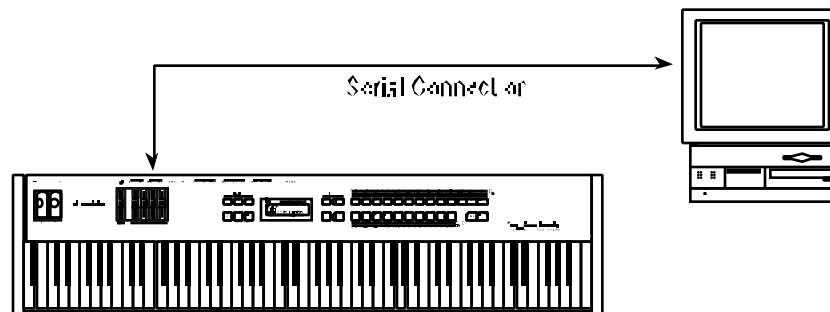

## THE SERIAL PORT

All of the following information about sequencing with the MIDI ports applies to operations with the serial port as well. The most obvious difference is that if you use the built-in serial port you won't need an additional MIDI interface.

If you already have the proper cables installed (and the Alesis serial driver, if you're using a PC-compatible computer), then you're almost ready to begin. Read about enabling the serial port in Part 1: Setup and Connections on page 14. You'll also find some very important information about using the serial port in conjunction with the MIDI Output jack in Part 4: Basic Operation on page 47. Look for the section at the bottom that goes over Global Edit mode pages 15 and 16.

Information about the Alesis Serial Driver and the cables you'll need in order to do this is also in Part 1: Setup and Connections on page 15.



## SELECTING THE KEYBOARD MODE

In a Mix, the QS's keyboard may be set up in several ways using the Keyboard Mode parameter found on Page 6 of Global Edit Mode. You need to determine which way is best for your application. The Keyboard Mode parameter determines how the keyboard will function with regard to MIDI:

- **OUT 01 – OUT 16.** Use this mode if you'll be sequencing parts for other MIDI devices in addition to the QS. Select OUT 01, and the keyboard will send on only MIDI channel 1 (or channel 2 if you select OUT 02, and so on). In this case the sequencer must be used to set the MIDI channel of each track you want to record.

*Note: With this mode selected you will not hear the QS unless your sequencer echoes the MIDI data back to the QS's MIDI IN. (This is also one way of verifying that the sequencer is set to receive properly.) "Local" control of the QS is turned OFF with this mode selected, so if things get disconnected somehow you won't be able to play anything from the QS's keyboard. For example, this could happen if you accidentally select the "desktop" on your computer, temporarily disabling the sequencing application.*

So be sure to set up your sequencer to "echo" the MIDI data back to the QS. You can then set up the QS to pass the "auto-channelized" data along to other MIDI devices by setting its MIDI Out Mode to Thru (Global Edit mode, page 16). If the sequencing software is set up correctly, you'll be able to play on a different MIDI channel with each new track you record.

- **NORMAL.** Use this mode if the Mix is split or layered and sending on many MIDI channels at once, and the sequencer will be able to record all channels at one time. Good for capturing live performances in Mix mode.

This will only work if you have MIDI Out enabled for every MIDI channel within the Mix which you would like the sequencer to record. The MIDI Out parameter is on page 2 of the KEYBOARD/MIDI function in Mix Edit Mode. Once you're in Mix Edit Mode, select the MIDI channel for which you would like to set this up by pressing its [SELECT] button ([0] - [9] for channels 1-10, [00] - [50] for channels 11-16).

- **CH SOLO.** Use this mode if you're sequencing with the QS alone (no external MIDI modules). The keyboard only sends on one MIDI channel at a time, and you change the channel on the QS for each separate track on the sequencer. Naturally, this only works in Mix Mode, because Program Mode is kind of already *in* Channel Solo mode by default.

This mode is automatically selected by the QS when the General MIDI function is set to ON.

*Note: In NORMAL or CH SOLO mode, the QS sounds are internally played from the QS keyboard, so any echo features of the sequencer should be turned off.*

## PROGRAM ASSIGN FOR EACH MIDI CHANNEL

Assign Programs to the 16 channels of the Mix by using the [◀PAGE] and [PAGE▶] buttons to select a channel (the silkscreening also identifies those as the [MIX CHANNEL PROGRAM SELECT] buttons). Then use the [0] – [9] and [00] – [120] buttons to select a Program for that channel. If desired, you can use the [◀BANK] and [BANK▶] buttons to select a Program from any of the internal or card banks.

## SENDING AND RECEIVING BANK SELECT MESSAGES

The QS will send and respond to MIDI Bank Select messages in the form of MIDI Controller 0. The value of Controller 0 determines which bank is to be recalled (User, Preset 1–3, GenMIDI, CardA, Card B). A total of 11 banks are accessible between the cards. The way the QS handles Bank Select messages depends on the MIDI Program Select mode (Global Edit Mode, page 14):

### MIDI PrgSl: OFF

The QS will neither transmit nor receive Bank Select messages or Program change commands with this setting.

### MIDI PrgSl: ON

**Reception: Program Mode.** If a Bank Select (controller 0) message with a value of 0 is received, it will cause the User Bank to be recalled. If a Bank Select message of 1 is received, Preset Bank 1 will be recalled. Additionally, if a Sound Card is inserted, the Card Banks can be selected using Controller 0 values between 5 and 15. Values higher than 15 are “wrapped around” and will start through the Banks order again. This means that a Controller 0 message with a value of 16 or 32 will recall the User Bank, while a value of 17 or 33 will call up Preset Bank 1.

**Reception: Mix Mode.** Same as above, except the Mix itself will not change Banks. The word “EDITED” will appear in Mix Play mode screen, because the Mix has been altered to point to another bank on one of its MIDI channels. But you have to look inside the Mix to see that the Bank change occurred.

**Transmission: Program Mode.** If a new Bank is selected using the [BANK] buttons, a Bank Change message will be transmitted. See Reception: Program Mode for a description of which values will be sent for each Bank as it is selected.

**Transmission: Mix Mode.** If a new Bank is selected and any of the channels within the Mix have their MIDI Out parameters set to ON (Mix Edit Mode, Keyboard/MIDI function, Page 2), a Bank Select message (followed by a Program change) will be transmitted for each of those MIDI channels.

In **Mix Program Select Mode** (where you choose the Programs within the Mix), any channel which has its MIDI Out set to ON will transmit Bank and Program changes from within the Mix, just like in Program Mode.

## MIDI MixSl: CH 1-16

**Reception: Program Mode.** Same as with MIDI PrgSl: ON (see above).

**Reception: Mix Mode.** In this mode, when a Bank select message is received on the channel specified by this parameter, the Mix itself will change Banks. Any Program change command on this same channel will call up an entire Mix as if it were a Program. All other channels within the Mix will behave the same way they do when MIDI PrgSl: ON is selected (i.e., they receive Bank and Program changes normally).

**Transmission: Program Mode.** Same as with MIDI PrgSl: ON (see above).

**Transmission: Mix Mode.** If a new Bank is selected, the Bank number of the Mix itself will be transmitted on the channel specified by this parameter. Selection of another Mix in the same bank will send a Program change command which matches the Mix number.

In **Mix Program Select Mode** (where you choose the Programs within the Mix), changing the Bank of any Program within the Mix will not send a Bank Select command. Selecting a new Program within the Mix will not send a Program change command.

*Note:* Bank change messages will be ignored if General MIDI Mode is enabled, so that only Programs within the General MIDI Bank (GenMIDI) can be recalled via MIDI Program changes. The MIDI Program Select parameter will automatically be set to MIDI Prg: ON.

## USING THE QS AS A MASTER KEYBOARD

Mix Play Mode also allows the QS to function as a very powerful MIDI master keyboard. You can layer the QS's internal sounds with those of several external synthesizers by adjusting the proper parameters in Mix Edit mode.

For instance: You probably already know that you can layer and/or split several QS Programs in Mix Mode while simultaneously playing external synthesizers on those same MIDI channels. But the *real* power comes from using QS MIDI channels which have their Keyboard and MIDI Input parameters turned OFF. When this is the case, you can send a combination of MIDI Program changes and MIDI volume and panning commands to the external devices to select and blend them precisely the way you want with internal Programs on other channels. What's more, the QS can transpose the outgoing MIDI note numbers so you can play high octave brass sounds from an external device in the lower region of the keyboard, and/or layer external mid-range pads with high QS strings in the upper region.

The QS is so versatile as a master keyboard that if you play live, it could prove indispensable. Or if you just like having that huge, perfect, multi-MIDI-module stack for inspiration in your studio, the QS will call it up for you just the way you want it every time.

There's a detailed description of the parameters you would use to make all of this happen in *Part 7: Editing Mixes*. If you haven't read that chapter yet, go check out the section that describes the KEYBOARD/MIDI function (button [90]). If you're already familiar with those parameters, you're not far from being able to do the things listed in the previous paragraph.

Note: Be sure to check out the following pages for some useful information regarding:

- Bank Select and Program changes (*Part 5: MIDI*, pages 52 and 53)
- Making sure the Effects Patch doesn't change in a Mix when Program changes are received (*Part 6: Editing Effects*, page 64)
- Enabling and disabling the Wheels, Aftertouch, Sustain Pedal, and Controllers independently *per channel* (*Part 7: Editing Mixes*, page 105)
- Assigning different MIDI controller numbers to the four sliders and two variable pedal inputs (*Part 4: Basic Operation*, pages 44 and 45). Remember that even if you're not using pedals, the controller numbers you assign to them are still available as Mod sources via MIDI.
- Setting up the A-D controllers so they either control internal parameters, send data to MIDI, or both (*Part 4: Basic Operation*, page 47).

## MAKING IT HAPPEN

The three parameters found under the KEYBOARD/MIDI button determine how the QS will function as a MIDI controller. For example:

- To play both an internal Program and an external MIDI sound source on a given channel, set both the Keyboard parameter and the MIDI Output parameter to ON.
- To play an internal program from the QS's keyboard and not trigger an external MIDI module on a given channel, set Keyboard to ON and MIDI Output to OFF.
- To play an external MIDI sound source but leave the QS silent on a given channel, set its MIDI Output parameter to ON and its Keyboard parameter to OFF. But while you're at it, you may as well turn MIDI Input to OFF, because...
- To send volume, panning, and transposition information to an external MIDI sound source on a given channel, set MIDI Out to ON and set both MIDI Input and Keyboard to OFF. This is covered in greater detail on the next page.

*Remember: This only works if that channel isn't playing a QS Program.*

Note: When using the QS for this sort of thing, be sure the Keyboard Mode is set to NORMAL and the MIDI Program Select parameter is set to ON (Global Edit Mode, Pages 6 and 14). For more information, see *Part 04: Basic Operation*. There's also some good stuff about setting the Keyboard mode in this chapter. Look for the section called "Selecting the Keyboard Mode" under "Using an External Sequencer."

## TRANSMITTING MIDI VOLUME AND PANNING

Each Channel in a Mix can transmit its volume and panning settings via MIDI. For each channel on which you wish to transmit this data, MIDI Out must be set to ON and MIDI Input and Keyboard must be set to OFF (as explained in the KEYBOARD/MIDI section on page 102). Also, the Keyboard mode must be NORMAL and the MIDI Program Select parameter must be set to ON (Global Edit Mode, Pages 6 and 14).

If a channel is set up this way:

- whenever a Mix is recalled (via the front panel or via MIDI), volume and panning information will be transmitted for that Channel;
- whenever that Channel's "Level" parameter is edited, volume information will be transmitted as Controller #7 on that Channel;
- whenever that Channel's "Pan" parameter is edited, panning information will be transmitted as controller #10 on that Channel. However, panning information will *not* be sent if the Channel's "Pan" parameter is set to PROG.

The seven pan positions in a Mix send the following controller #10 values:

Mix Pan value	CC#10 value
3>	127
2>	107
1>	85
<>	64
<1	43
<2	21
<3	0

Conversely, if you want to change the panning of a QS Program via MIDI, here is what you'll get if you transmit a given controller #10 value:

CC#10 value	Mix Pan value	Placement
0-20	<3	(hard left)
21-42	<2	(mid left)
43-63	<1	(soft left)
64-84	<>	(center)
85-106	1>	(soft right)
107-126	2>	(mid right)
127	3>	(hard right)

## **TRANSPOSING MIDI NOTE NUMBERS PER ZONE**

You can transpose different zones on the QS's keyboard so they send higher or lower MIDI note numbers to external MIDI devices than you are actually playing.

Here's how: Once the initial conditions are met (MIDI Out set to ON, Keyboard and MIDI In set to OFF), all you have to do from within Mix Edit mode is press the Pitch function button [70] and "tune" the external MIDI devices as if they were internal Programs using pages 1 and 2. That's it!

Between the Octave and Semitone parameters (pages 1 and 2, respectively), this gives you a +/- 3 octave control over your other gear in any zone! And even if your external MIDI devices are being transposed in this manner by the QS, they will follow the [TRANSPPOSE] button even further up or down.

Combine this with the multi-octave range of your QS and that means there isn't any note you can't reach in the entire MIDI specification of 128 possible notes! Now you see why we think the QS is such a powerful controller.

## **SENDING CARD SEQUENCE DATA TO EXTERNAL DEVICES**

There is an option box in Sound Bridge which allows you to set up the sequences on a given card so they will be transmitted from the QS's MIDI Output jack. Basically what it does is toggle the QS's MIDI Out parameter between Out and Thru (Global Edit Mode, page 16).

A setting of OUT causes Card sequence data to play QS Programs only, while allowing the MIDI Out jack to function relatively normally (so you can play your MIDI gear from the keyboard while the sequence is playing).

A setting of THRU passes sequence data on to external MIDI devices from the MIDI Output jack of your QS, allowing both QS Programs *and* sounds from other MIDI devices to be played from a Card sequence. You will be able to play QS Programs from its keyboard, but you will not be able to play external MIDI devices while the sequence is running.

*Note: It is highly inadvisable to enter Global Edit mode and toggle between these two settings while a sequence is running. If this happens, the QS could inadvertently send large bursts of data to your external MIDI devices.*

## SAVING PROGRAMS VIA MIDI Sys Ex

As an alternative to storing data to a card, the QS lets you transmit internal data via the MIDI Output connector in the form of System Exclusive messages. This data can be sent to a storage device, or recorded into a MIDI sequencer, or sent to another QS or a QSR. You have a choice of sending any single Program in the User bank (00 to 127), or what is in the current Program Edit buffer, or what is in any of the 16 Mix Edit Program buffers, or the entire User bank (100 Mixes and 128 Programs, including their Effects Patches) plus Global data. In the case of sending data to another QS, you can send any individual Program to the same location or any other location in the receiving QS, including any of its 17 Program Edit buffers.

### To send the entire User bank via MIDI:

- ⑩ Connect a MIDI cable from the QS's MIDI Out to the MIDI In of a device capable of receiving the data (a MIDI sequencer, another QS, etc.).

☞ Press [STORE].

- ① Press [PAGE ►] six times to select the proper page of the Store function.  
*The display will look like this:*

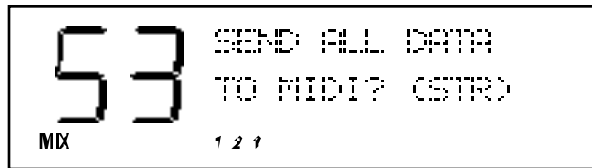

- ④ Press [STORE] to transmit the data out the MIDI Out connector.  
*While transmitting the data, the display will temporarily read "SENDING OUT MIDI DATA.....".*

### To send a single Program via MIDI:

- ⑩ Follow steps ⑩ and ☞ in the instructions above.

☞ Press [PAGE ►] seven times to select the proper page of the Store function.  
*The display will look like this:*

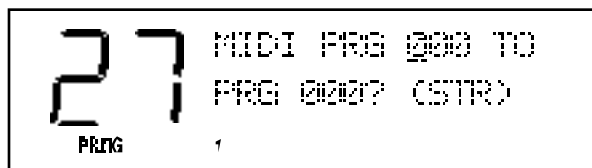

- ① Use the [CONTROLLER D] slider and the [VALUE] buttons to select a Program to transmit. You may select any Program in the User bank (000 to 127) or the Program Edit buffer (EDIT) or any of the 16 Mix Edit buffers (EM01 to EM16).  
*As this value is changed, the second parameter (destination) will be linked. This is because most often you will want to transmit a Program to the same Program location. The only time to do otherwise is when sending to another QS (see next page).*
- ④ Press [STORE] to transmit the data out the MIDI Out connector.



**To send a single Program via MIDI to a *different* Program number:**

- ⑩ Follow steps ⑩ through ① in the instructions above.
- ☞ Press [PAGE ►] one more time to advance the cursor to the lower section of the display.
- ① Use the [CONTROLLER D] slider and the [VALUE] buttons to select the Program number to which you would like to send the Program.
- ④ Press [STORE] to transmit the data out the MIDI Out connector.

The procedure is similar for sending Mixes. The next two pages of the Store function allow you to send any one of the Mixes to the same Mix location or the Mix Edit buffer in all the same ways to all the same types of devices.

But keep in mind that just because you're storing a Mix to MIDI doesn't mean that all of the Programs are being taken with it. It's similar to having edited every single Program in the Mix as well as having edited the Mix. You'd have to individually store each of these to a location in the User bank or to a card, right? It's the same with sys-ex transfers. If you want that Mix to sound the same in someone else's QS, you're going to need to send along the Programs out of which it was constructed.

So depending on how customized the Programs are, it might make more sense to go ahead and use the "SEND ALL TO MIDI" command and give them the entire bank.

But make sure s/he knows to back up his or her User bank before loading it in!

## EDITING PROGRAMS VIA MIDI SYS EX

This is the single scariest thing a person can try to do with a QS (or any other synth, for that matter). It's the MIDI equivalent of genetic engineering. But if you're into doing hexadecimal conversion and know the QS extremely well, we wanted to let you know that we have some documents which you can request from Product Support here at Alesis which will assist you. Call or e-mail us (number and addresses listed in Appendix A: Troubleshooting).

There are two documents available:

- 1) **The Sys-Ex document.** Aptly named, it's the one which lists every parameter in the QS and covers briefly how to represent them in System-exclusive form.
- 2) **The Do-It-Yourself document.** The DIY document (as it is commonly called) gives you an example of how to address one parameter in Sys-ex form, and then turns you loose.



## PART 6

# EDITING EFFECTS

The QS7.1/QS8.1 has an extensive and versatile built-in effects processor. Your own ears will have told you this by now, of course, since lots of the presets in a QS use the effects to some degree.

What we'd like to discuss here is a first step in how you can go further than just appreciating and playing the Programs and Mixes that came already loaded into your instrument. Why not tweak their effects to suit your individual need and tastes, or come up with cool new sonic treatments all your own?

Why not, indeed? This section shows you how.

*Assigning different Sounds, Programs, or Mixes to a specific Effect Configuration is done in either Program Edit Mode or Mix Edit Mode. Accordingly, that procedure is described in Part 7: Editing Mixes and Part 8: Editing Programs. Here our main focus will be on giving you what you need to make changes in the Effects settings themselves.*

## BASIC INFO

Things you should know:

- **There is an *Effect Configuration* stored with every Program.** Even when it isn't set to be doing anything, it's still there.
- **The Effects are only available to the Main Outputs, not the Auxiliary Outputs.** But you can run a signal to the Aux Outs and send its effected signal to the Mains by leaving that Sound's FX Level parameter set to a value above 00.
- **The QS can only run one Effect Configuration at a time.** This goes for when you play Mixes, too. (An example: Three different Programs can have three entirely separate Effects. But if you combine those same three Programs in a Mix, you will have to choose *one* Effect Configuration to process everything, and lose the other two.)
- **There are five basic Effects Configurations to choose from.** This may not seem like a lot, but because of all the parameters that are available there is actually quite a lot of flexibility.
- **The different Effects Configurations have different sets of parameters** (including the number of inputs, which are referred to as *Effects Sends*).
- **Effect Configuration settings are easy to copy from one Program or Mix to another.** This is a great feature. If some existing Program or Mix has an Effect that you like, you don't have to laboriously write down and re-enter parameter settings in order to apply it elsewhere. Just grab and copy!
- **Each Sound within a Program can be assigned to its own separate Effects Send** (within the limits of the chosen Effect Configuration).
- **You can enter Effects Edit Mode from either Program Mode or Mix Mode.**



## ENTERING EFFECTS EDIT MODE FROM PROGRAM MODE

If you are in Program Mode and wish to edit the Effect of the Program you are currently listening to, press the [EDIT SELECT] button *twice*.

The first press will take you into Program Edit Mode; you want to go past that, which is why you have to press the button a second time.

Once you are in Effects Edit Mode, the display will change to look something like this (the actual parameter you see in *your* display will be the same as the last Effect parameter you edited, whatever that was):

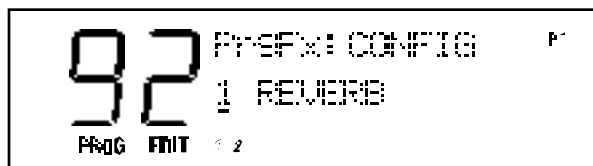

To exit and return to Program Mode, press [PROGRAM].

If you'd rather go to Mix Mode instead, press [MIX].

*Continuing to press [EDIT SELECT] here will switch you back and forth between Program Edit Mode and Effects Edit Mode. This is a handy convenience when creating and editing, since Program parameters and Effects parameters can have a big effect on each other in terms of the way a specific Program ultimately sounds when played.*

## ENTERING EFFECTS EDIT MODE FROM MIX MODE

If you are in Mix Mode and wish to edit the Effect of the Mix you are currently listening to, press the [EDIT SELECT] button *three* times.

The first press will take you into Mix Edit Mode. The second will take you into Program Edit Mode (so you can tweak the Programs that are part of this Mix). And the third press will finally get you into Effects Edit Mode.

Once you are there, the display will change to look something like this (as mentioned just above, you may see a different parameter than this depending on whether you've previously worked with or explored this mode):

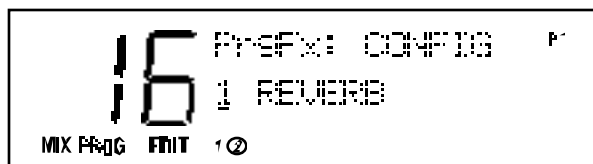

*Continuing to press [EDIT SELECT] here will cycle you through Mix Edit Mode, Program Edit Mode, and Effects Edit Mode (in that order).*

## NAVIGATING IN EFFECTS EDIT MODE

There are certain basic methods that apply to moving around the various displays in Effect Edit mode.

- **Using the [40] – [120] buttons.** These are used to select among possible Effects parameters. If you look at the middle row of titles printed above these buttons, you'll see the list: Configuration, EQ, Mod, Lezlie, Pitch, Delay, Reverb, Overdrive, and Mix .
- **Using the [◀ PAGE] and [PAGE ▶] buttons.** Some parameters have more than one "page" of settings. If more pages are available, then pressing the [PAGE] keys will cycle you through them. *You can always tell what page you are on by looking at the indicator in the upper right corner of the display: P1 for Page One, P2 for Page Two, and so forth.*
- **Using the [00] – [30] buttons.** These buttons select among the four possible Effect Sends, as indicated by the middle row labels just above them.

Not all effects are available in each Configuration. For example, if you were to select the PITCH function on Effect Send 4 in Configuration #1, then the display would look like this:

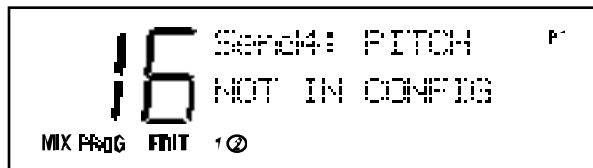

NOT IN CONFIG means just what it says: you can't use the function you are trying to invoke here, because the current configuration isn't designed to include it — not at this location, anyway.

*Complete diagrams of all five Effects Configurations are included later in this section.*

## SELECTING FROM AMONG THE AVAILABLE EFFECTS PATCHES IN A MIX

When you want to edit a Program's Effect settings, it's easy: call up that Program, go into Effects Edit Mode, and start tweaking.

Same for Mixes, too. But there's a powerful twist available to you any time you want to explore changing Effects. Here it is.

Only *one* Program's Effect is active in a Mix. That's a given. But all the other Programs in a Mix have their associated Effects, too — it's just that these Effects are turned off for now. A quick and useful way to make Effect changes in a Mix, therefore, is to simply choose whole new Effects from among those that are immediately available.

This choice is made at the Mix Edit level, not the Effects Edit level, because you aren't actually editing the Effects — just turning them on and off within the Mix itself.

- Start in Mix Mode. If you aren't there, or aren't sure you are there, press [MIX] once to make certain.
- Press [EDIT SELECT] a single time.
- Press [80]. As you can see if you glance at the MIX row of captions printed above the [SELECTION] buttons, this takes you to the Mix's EFFECT parameters.
- Go to Page Two of this parameter by pressing [PAGE▶] a single time. The display will look something like this:

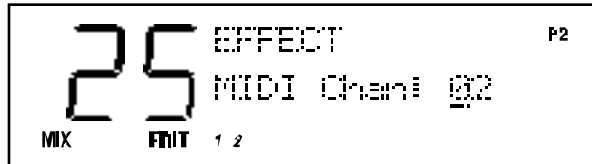

- Now use the [DATA] slider or the [VALUE] buttons to select a new MIDI channel. The range is 01-16.

Back in the section of *Part 4: Basic Operation* called *Changing The Programs In A Mix*, we showed you that each MIDI channel in a Mix has some Program or other assigned to it (even if those Programs aren't turned on and sounding). When you change the MIDI channel selection here in Page Two of the Mix Effect parameters, you are telling your QS to do two important things:

- **Process the Mix using the Effect settings of the Program associated with this MIDI channel**, even if that Program is not currently sounding.
- **Accept MIDI controller data for the Effect's Modulators *only* over this channel, and no others.** (Never fear: Modulators will be explained clearly a little later in this section.)

## THE "FX PROGRAM CHANGE VIA MIDI" FUNCTION

Now that you've chosen an Effect (by choosing a MIDI channel), there's one more useful tweak to be aware of. It's back on Page 1 of this setting, so press [◀PAGE] to get there. The display will look like this:

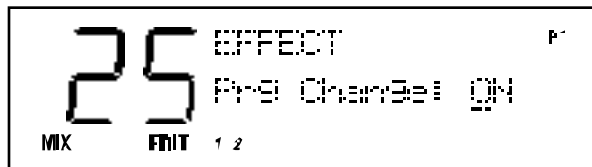

This parameter determines how your QS's Effect will respond to MIDI Program Change commands.

- When it is set to ON, any Program Change coming in over the MIDI channel selected for Effects will select a new Program *and* its associated Effect.
- When it is set to OFF, then such Program Changes will select new Programs but *not change* the current Effect setting.

Both are quite useful, depending on just what you want to do. The default is OFF, because that way the Effect for a Mix does not change even though you may select different Programs for the Effects Channel.

## HOW THE DISPLAY CHANGES WHEN YOU ALTER AN EFFECT

Whenever you enter on of the Edit modes, the word EDIT appears in the lower left portion of the display. Once you have actually changed something, that indicator changes to read EDITED.

This is a handy reminder, telling you that there is now a difference between what's in the edit buffer and what is stored in memory for the selected Program (which is where the Effect Patch resides).

## STORING EFFECT PATCHES IN PROGRAM MODE

Effects are part of Programs. Because of this, when you store a Program you automatically store its Effect along with it. Here's how.

- While in Effects Edit mode, press [STORE].

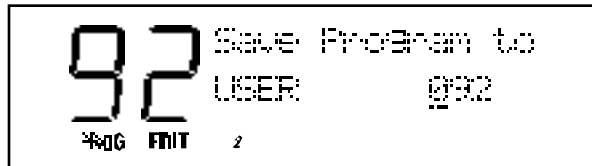

- To store the edited Program (along with Effect) into its original location, replacing what was there before, simply press [STORE] again.
- To store the edited Program and Effect into a different location, use the [00] – [120] and [0] – [9] buttons to select a Program number from 000 – 127 in the User Bank.
- If you want to store this edited Program somewhere other than the User Bank, you'll need to have an appropriate RAMcard inserted into one of the two back panel [PCMCIA EXPANSION CARD] slots. The storage procedure is the same, except that you use the [BANK] buttons to jump from the User Bank to a bank on a RAMcard.
- In all three cases, when you are ready to save your Program and Effect, simply press [STORE] again and it will be done.

## STORING EFFECT PATCHES IN MIX MODE

As we said earlier, when your QS is in Mix Mode or Mix Edit Mode, the Effect Patch is that of the Program number assigned to the Effect Channel. Storing the Mix will save this number, but will not store any changes you may have made to the Effect Patch itself.



- If you press [STORE] twice while editing a Program assigned to the Effect Channel, then both the Program and its Effects will be stored.
- If [STORE] is pressed twice while editing a Program on some *other* Channel than the Effect Channel, then the edited Program will be stored with no change in its previous Effect settings.
- If [STORE] is pressed twice while in Mix Edit Mode, then only the Mix parameters will be stored. The settings for individual Programs and Effects within the Mix will be left unchanged.

## COPYING EFFECTS FROM ONE PROGRAM TO ANOTHER

When you want a Program to use the Effect from some other Program, you can copy that other Program's Effect *into* the Program you are working on.

This is done, within Store Mode, using the *Copy Effect* function. This subfunction can be found on one of Store Mode's many pages.

(Remember how to move around subfunctions? Just get to the function you want, and then use the [PAGE] keys to cycle the display through all currently available settings.)

One slight twist here is that you can only copy an Effect patch to a Program in the User bank. The only way to copy an Effects patch onto a RAMcard is to copy the Program which contains it. No problem! If you've just *got* to have that RAMcard's Zither program going through that preset organ's distorted Lezlie Effects patch, just choose a location in the User bank to place the zither while you work on it. Once it has been joined with the Effects patch you want it to have, store the Zither program back to its original location on the RAMcard (or to a new one). The zither will carry its Effects patch with it, as you know.

Here's the procedure for copying an Effect to the User bank:

- 1) Select the Program which contains the Effect you wish to copy.
- 2) Enter Store Mode.
- 3) Press the [PAGE ►] key three times and you will see the following display:

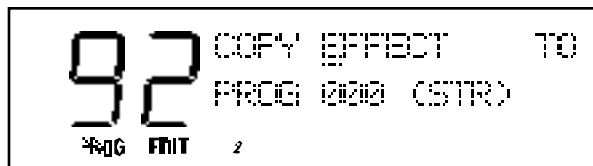

- 4) Press the [PAGE ►] key one more time so the cursor is under the "P" in "PROG".
- 5) Use the [EDIT VALUE] slider or the [VALUE] buttons to select the User Program number that you would like to copy the current Effect to.

- 6) Press [STORE].

## KEEPING TRACK: THE INTERACTION OF EFFECTS, PROGRAMS, AND MIXES

Effect Send levels and Configuration assignments are saved as either part of a Program (when in Program Edit mode), or as part of each Channel in a Mix (when in Mix Edit mode). Keep in mind that these are separate from any changes that you might make to a given Configuration's parameter settings!

If you are in Mix Mode, for example, and make changes in both the Mix and the underlying Effect, you will have to store not *only* the Program that is on the Effect Channel (thus saving its Effects Patch), but also the current Mix. If you don't do both, then this Mix won't sound the way you expect it to the next time you call it up.

Another thing to be aware of is that a single Program might be part of more than one Mix. So if you change the Effect in that Program, the change will ripple through and be heard in *every* Mix which has its Effect Channel set to use that Program's Effect. (The way around this is to save the altered Program as a new Program, and assign this new version to the Mix in question in place of its previous version.)

## PICKING AN EFFECT CONFIGURATION

The starting point of every Effect is its Configuration, which controls all routing and parameters. Each is a unique arrangement of multiple effect blocks, distributed across anywhere from two to four of the effect sends. Configurations also determine where each block's input comes from, and where each block's output goes — to the Reverb, to the next effect in line, or straight to the main outputs.

The Configuration diagrams that follow will help guide you through the many choices that are possible in each different configuration. We recommend that you refer to them often as you experiment with creating your own Effects or editing existing ones.

*Every time you select a new Configuration you run the risk of resetting many of the routings and parameters in that Configuration to their default values. So always press [40] in Effects Edit Mode to select a Configuration FIRST, before doing any other editing.*

The five Effect Configurations are:

- 1 Reverb
- 2 Reverbs
- Lezlie+Reverb
- Reverb+EQ
- Overdrive+Lezlie

To pick a Configuration, enter Effects Edit Mode and then press [40], the button that has CONFIGURATION printed above it. The display will change to look like this:

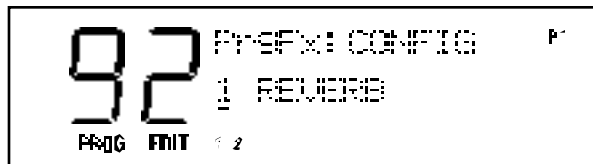

Use the [▲ VALUE] and [VALUE ▼] buttons or the [EDIT VALUE] slider to select one of the five possible Configurations. As you scroll through the choices, each one's name will appear in the display.

# CONFIGURATION #1: 1 REVERB

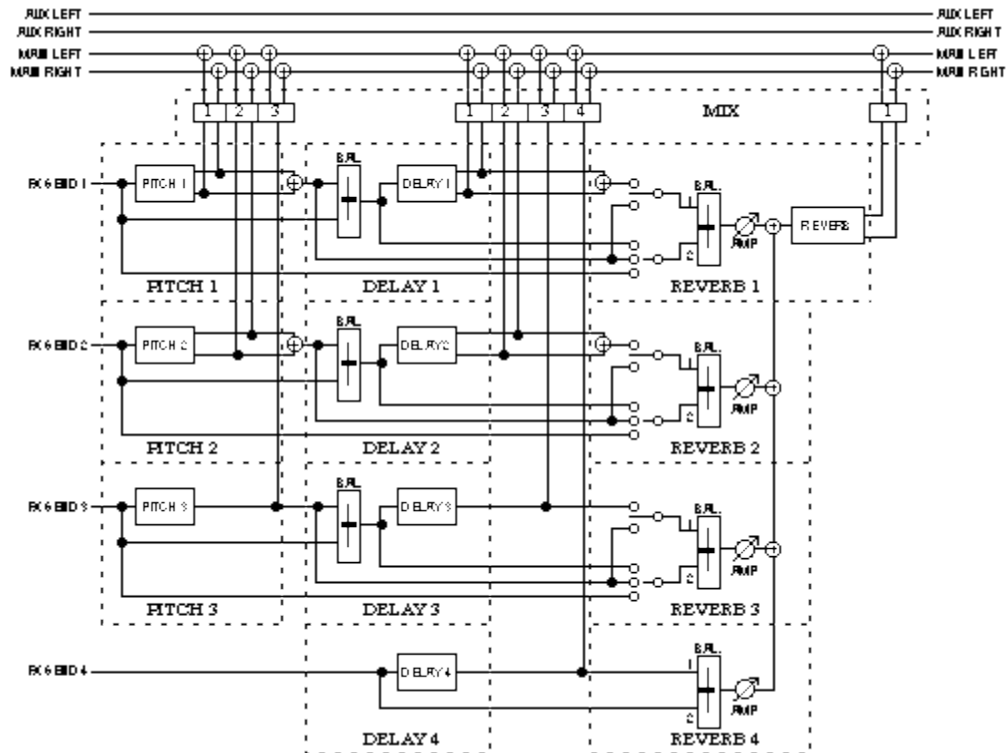

Pitch 1	Delay 1	Reverb 1
Mono Chorus	Mono Delay	Plate 1
Stereo Chorus	Stereo Delay	Plate 2
Mono Flange	Ping-pong Delay	Room
Stereo Flange		Hall
Pitch Detune		Large
Resonator		Gate
		Reverse

Pitch 2	Delay 2	Reverb 2
Mono Chorus	Mono Delay	Balance and Level to Reverb 1
Stereo Chorus	Stereo Delay	
Mono Flange	Ping-pong Delay	
Stereo Flange		
Pitch Detune		
Resonator		

Pitch 3	Delay 3	Reverb 3
Mono Chorus	Mono Delay	Balance and Level to Reverb 1
Mono Flange		
Resonator		

Delay 4	Reverb 4
Mono Delay	Send/Delay Mix & Level to Reverb 1

At first glance this diagram may look a little daunting, but if you take a moment to trace the lines and read the component captions, things will become clear.

Think of it as a kind of “road map” charting your audio signal’s progress from starting point through to its ultimate destination — the [LEFT] and [RIGHT] outputs shown at the top of the page.

- 1) The dotted lines indicate the divisions between different functional blocks.
- 2) The solid lines indicate signal paths between the blocks and controls.
- 3) In general, signal flow moves from left to right.
- 4) The number next to each function name represents one of the four effect sends. For example, Delay 2 refers to the Delay effect on effect send 2.

## HOW “1 REVERB” IS ARRANGED

This Configuration provides three Pitch effects, four Delay effects, and one Reverb effect, arranged as follows:

- 1) Sends 1 and 2 can be stereo and have a selectable Pitch effect (Chorus, Flange, Pitch Detune, or Resonator) followed by a mono or stereo Delay effect.
- 1) Send 3 offers three possible Pitch effects (Mono Chorus, Mono Flange, or Resonator) followed by a mono Delay effect.
- 2) Send 4 is a mono Delay effect only.
- 3) The single Reverb effect is selected and set in Send 1. Reverb parameters that set the sound of the reverb itself (such as high and low decay, reverb type, predelay, etc.) are found only when “Send1” is displayed. Within this limitation, however, there is still tremendous flexibility of Reverb routing and control on a per-Send basis: for example, each of the four Sends has its own controls for dry/wet ratio, and specific input point. (In Sends 1 through 3 you can take Reverb inputs from the Send input itself, the output of any Pitch effect, and the input or output of Delay effect, either individually or in any combination. In Send 4, the two possible inputs are the input and output of Delay 4.)
- 4) Each Pitch, Delay and Reverb module has its own independent Mix output level which controls how much signal is routed directly to the [LEFT MAIN] and [RIGHT MAIN] outputs. This Mix function is what you use to determine how much of each Effect component will be heard. Mix 1, for example, is where you control the outputs of Pitch 1, Delay 1, and Reverb 1 to the main outputs.

*The Mix parameter controls how much each Effect block feeds directly to the main outputs. It does not, however, control how much each block feeds to the blocks that follow it. For example, when Pitch 1’s Mix control is set to 0, it is still fully available as an input to Delay 1 and Reverb 1.*

# CONFIGURATION #2: 2 REVERBS

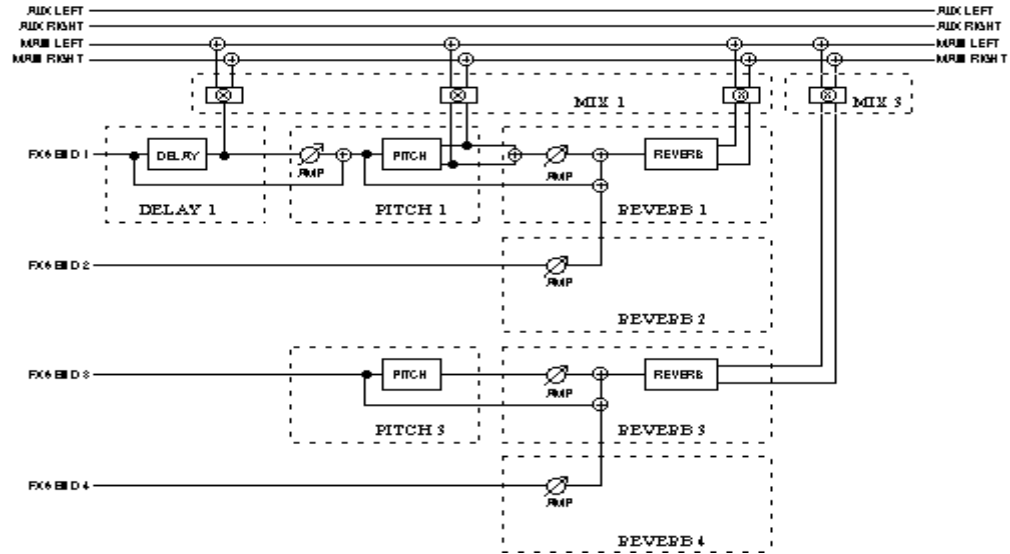

Delay 1	Pitch 1	Reverb 1
Mono Delay	Mono Chorus Stereo Chorus	Plate 1 Plate 2 Room Hall Large Gate Reverse
		<b>Reverb 2</b> Level to Reverb 1
	<b>Pitch 3</b> Mono Chorus	<b>Reverb 3</b> Plate 1 Plate 2 Room Hall Large Gate Reverse
		<b>Reverb 4</b> Reverb 4 Level to Reverb 3

## HOW "2 REVERBS" IS ARRANGED

As you can see by glancing at the diagram, this Configuration differs considerably from the first! Here there are a single Delay, two Pitch effects, and two independent Reverb effects, arranged as follows:

- Send 1 is routed through a mono Delay, then a stereo Pitch effect, and finally a stereo Reverb effect.
- Send 2 has no effects of its own, but can be routed to the same Reverb effect as send 1 (if you wish).
- Send 3 is routed through a mono Pitch effect and then its own stereo Reverb effect.
- Send 4 has no effects of its own, but can be routed to the same Reverb effect as send 3 (thus echoing the relationship that Send 2 has with Send 1).
- The Delay, Pitch and Reverb outputs of Send 1 can be routed to the Mix control either singly or in any combination; while Send 2 is routed to the Mix only through the Reverb.
- Send 3 and Send 4 can be routed to their own separate Mix, but only through the second Reverb effect.

## CONFIGURATION #3: LEZLIE+REVERB

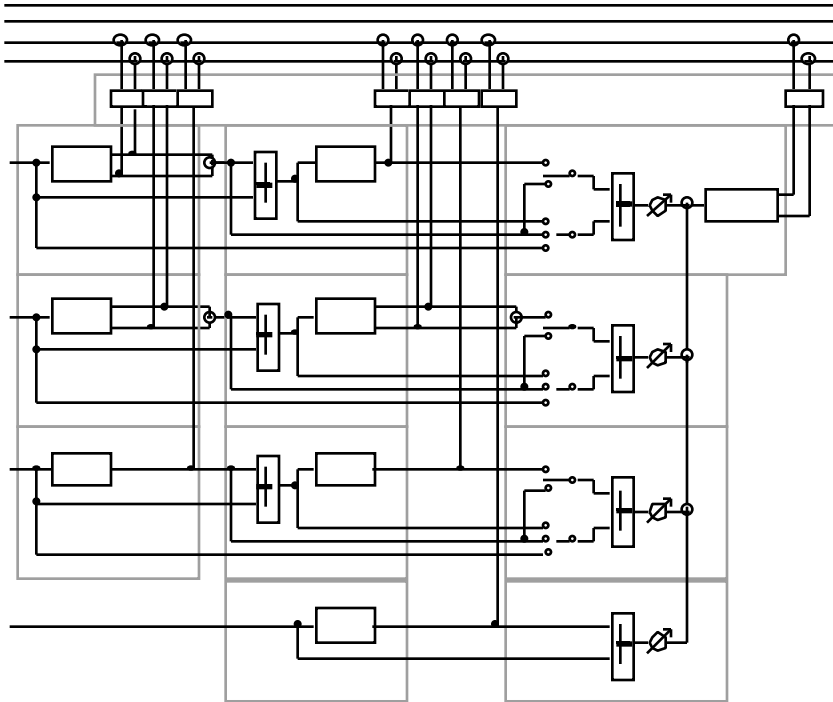

Pitch 1	Delay 1	Reverb 1
Lezlie	Mono Delay	Plate 1 Plate 2 Hall Room Hall Large Gate Reverse

Pitch 2	Delay 2	Reverb 2
Mono Chorus Stereo Chorus Mono Flange Stereo Flange Pitch Detune Resonator	Mono Delay Stereo Delay Ping-pong Delay	Balance and level to Reverb 1

Pitch 3	Delay 3	Reverb 3
Resonator	Mono Delay	Balance and level to Reverb 1

Delay 4	Reverb 4
Mono Delay	Mix and level to Reverb 1

### HOW "LEZLIE+REVERB" IS ARRANGED

This Configuration is structurally similar to Configuration #1. The big difference is that here the Pitch effect on Send 1 is a custom-designed stereo "rotating speaker" effect, and it is followed by a mono delay, not a stereo one.



## CONFIGURATION #4: 1 REVERB+EQ

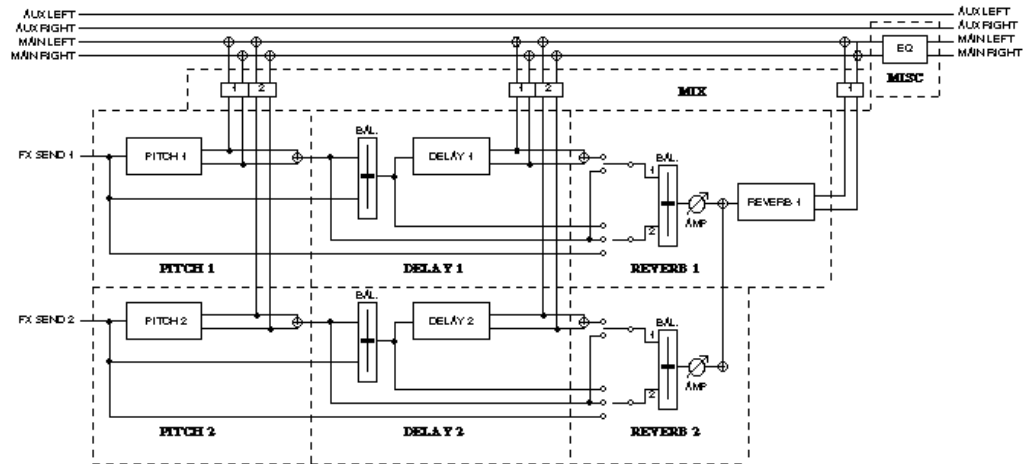

Pitch 1	Delay 1	Reverb 1
Mono Chorus	Mono Delay	Plate 1
Stereo Chorus	Stereo Delay	Plate 2
Mono Flange	Ping-Pong Delay	Room
Stereo Flange		Hall
Pitch Detune		Large
Resonator		Gate
		Reverse

Pitch 2	Delay 2	Reverb 2
Mono Chorus	Mono Delay	Balance and level to Reverb 1
Stereo Chorus	Stereo Delay	
Mono Flange	Ping-Pong Delay	
Stereo Flange		
Pitch Detune		
Resonator		

### HOW "REVERB+EQ" IS ARRANGED

The arrangement of Sends 1 and 2 in this Configuration are identical to those in Configuration #1. That's where the resemblance ends, though. In this Configuration:

- Sends 3 and 4 don't exist! (Literally. If you route Sounds which have their outputs set to OFF through these sends you will hear nothing at all, just the same as if you were trying to play your guitar through an amp that hasn't been plugged in.)
- In their place we've added a stereo shelving EQ module to the [MAIN] outputs.

The important thing to remember about this EQ — and one of its most useful aspects — is that it gives you bass and treble boost/cut control over *all* sounds coming out of the [MAIN] outputs. This means you can tweak EQs not just on the sounds being routed to the Effects Sends, but everything else being produced by your QS as well.

## CONFIGURATION #5: OVERDRIVE+LEZLIE

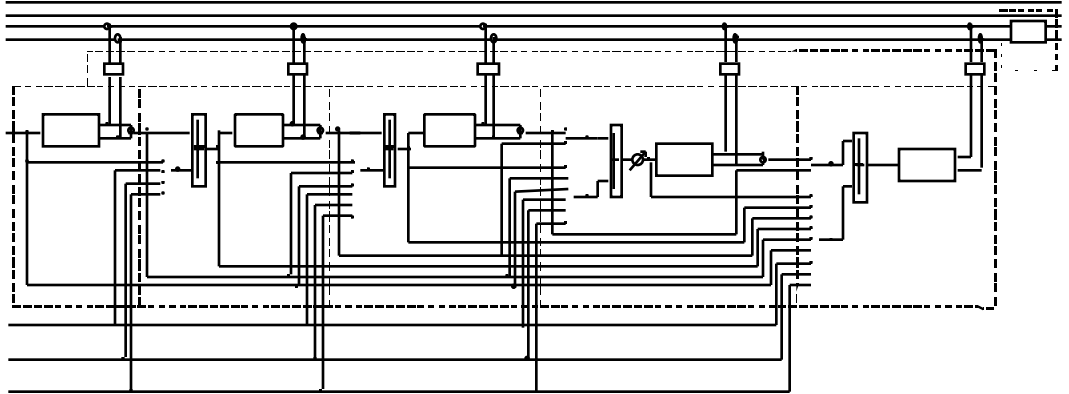

Pitch 1	Delay 1	Reverb 1
Mono Chorus	Mono Delay	Plate 1
Mono Flange	Stereo Delay	Plate 2
Resonator	Ping-Pong Delay	Room
		Hall
		Large
		Gate
		Reverse

## HOW “OVERDRIVE+LEZLIE” IS ARRANGED

This Configuration is as “all-for-one” as it gets: a total of *six* different effects, all at once, and all of them on Send 1.

Since this is an extremely linear Configuration, let’s follow the flow of the core signal step by step, then double-back to consider the complex extra routing choices which are available.

The main path:

- Send 1 is routed to an Overdrive effect which provides classic distortion.
- The output of the Overdrive is sent through a balance fader to a mono Pitch effect.
- The output of the Pitch effect is sent through a balance fader to a stereo Delay.
- The output of the Delay is summed to mono and sent through a balance fader to a stereo Reverb.
- The output of the Reverb is summed to mono and sent into a stereo Lezlie.
- The stereo output of the Reverb goes, as a stereo signal, to a shelving EQ.
- The stereo output of the EQ goes to the [MAIN LEFT] and [MAIN RIGHT] outputs.

Now, that's pretty impressive. But it isn't everything, not by any means. What *really* makes this Configuration so interesting to work with is the extreme flexibility of the routing.

Take another look at the diagram. In addition to the strictly linear flow written just above, this Configuration also offers:

- A Mix section that lets you combine the outputs from any or all of the first five Effects, in any combination, prior to routing the result to a global stereo EQ attached to the [MAIN] outputs.
- A fader-balanced open second input on the Pitch effect that can be connected to any one of the following: either the undistorted Send 1 or your choice of totally unprocessed Sends 2, 3, and 4.
- A fader-balanced open second input on the Delay effect that can tap any of the four Sends just mentioned, *or* the Overdrive's output, *or* the Pitch effect input.
- A fader-balanced open second input on the Reverb effect that can be connected to any of the four Sends just mentioned, the Overdrive's output, the Pitch effect's output, or the Delay effect's input.
- A fader-balanced open second input on the Lezlie that can be connected to any of the four Sends, the Overdrive's output, the Pitch effect's input, the Pitch effect's output, the Delay effect's input, or the Reverb effect's input.

Whew. That's a lot to play with!

## **ROUTING SOUNDS OR PROGRAMS THROUGH THE EFFECTS ONLY**

In normal operation, the final output of an Effect is mixed back in with the original Program or Mix, so that what you hear is a combination of the two. In some circumstances, however, you may want to play *only* the Effected sound. Or perhaps you want to split up a Program tonally by playing one or more of its Sounds only through the Effect. Here's how to do that:

- 1) Go into Program Edit mode.
- 2) Assign the Output parameter of the Sound/Program to OFF.
- 3) Assign the Effect Bus of that Sound/Program to one of the four Effect Sends.
- 4) Adjust the Effect Level as you wish.

## SETTING EFFECT SEND LEVELS

Effect Send levels are not set in Edit Effect mode. Instead, they are set in Program Edit mode (for Programs) and Mix Edit mode (for Mixes). For details, see *Part 7: Editing Mixes* and *Part 8: Editing Programs*.

## IF THE SEND INPUTS CLIP...

If the input to the Effect becomes overloaded while you are playing, then a “!” symbol will temporarily appear in the display. (You won’t see this while in any of the Edit modes; just from the Program or Mix Play mode screens.) You want to avoid this situation, of course, because clipping creates unnecessary noise and distortion. (And not the nifty kind you’d get from a fuzzbox or overdrive!) In extreme cases, overloading the Effects can even cause the signal to drop out for a second.

There are three possible fixes:

- Go into Effect Edit mode and reduce the Input levels for each effect function in the current configuration.
- If that isn’t enough, or changes the Effect unacceptably, then reduce the Effect level settings in the Program or Mix that is giving you the problem.
- Play softer. (This suggestion is half-joking and half-serious. But with a full-blown, mega-MIDI channel sequence going on, a slight reduction in velocity values on some of the more densely active channels will clear this up.)

## [00] TO [30] —EFFECT SENDS 1 - 4

Each Configuration uses Sends in a different way, so which of these buttons will do anything (and when) depends entirely on (a) what Configuration is selected, and (b) what Effect function you are currently in.

This can be a little confusing, at first. “Hey, wait a minute! I pressed that [10] button last time and it worked. How come it isn’t doing anything now?”

It really all does make sense, though, and as you get more experience working with Effects you’ll become pretty comfortable. Early on, however, we recommend that you keep this one tip in mind: *always start from the function, not the Send*. Once you are in the function and Page you want, you can jump around to see what’s happening on the other Sends by pressing [00] - [30], and change settings as you wish within the limits of the Configuration.

### TIP:

Now that we’re about to cover the various parameters in Effects Edit mode, don’t forget the “Double-button push” trick! This is where you push both of the [VALUE] buttons or both of the

**[PAGE]** buttons at the same time as a shortcut. You can read more about it in *Part 4: Basic Operation* on page 35.

## [50] — **EQ (CONFIGURATIONS 4 AND 5 ONLY)**

The stereo shelving EQ provides bass and treble boost to the *entire output* of the QS — not just the Effect Sends — and is only available in Configuration 4 (Reverb+EQ) and Configuration 5 (Overdrive+Lezlie). So if you push the EQ button while in Configurations 1, 2, or 3, you'll get the message "NOT IN CONFIG".

There are four EQ parameters:

- 1) **Low Frequency** (range: 30Hz to 180Hz)
- 2) **Low Frequency Gain** (0dB to +12dB)
- 3) **High Frequency** (3kHz to 10kHz)
- 4) **High Frequency Boost** (0dB to +9dB).

### **LO EQ FREQUENCY**

Range of Settings: 30Hz to 180Hz

Page 1

This parameter determines the cutoff frequency of the Lo EQ. Changing it will have no audible effect unless **Lo EQ Gain** (see below) is set above 0dB. When that happens, then all frequencies below and including this selection will be boosted.

### **LO EQ GAIN**

Range of Settings: 0dB to +12dB

Page 2

This parameter controls the amount of boost that will be applied to the frequencies selected by the **Lo EQ Frequency** setting (see just above).

### **HI EQ FREQUENCY**

Range of Settings: 3kHz to 10kHz

Page 3

This control adjusts the cutoff frequency of the Hi EQ. Changing it will have no audible effect unless **Hi EQ Gain** (see just below) is set above 0dB. When that happens, then all frequencies above and including this selection will be boosted.

### **HI EQ GAIN**

Range of Settings: 0dB to +9dB

Page 4

This determines how much boost will be applied to the range of frequencies selected by the **Hi EQ Frequency** parameter (see just above).

## [60] — **MOD**

Mod stands for “modulation.” So naturally enough the Mod Function lets you modulate up to two effects parameters at a time, either via MIDI or from the keyboard and front panel controllers of your QS. This is extremely useful for expressive real-time performance while playing live or recording or sequencing.

There are two Modulation assignments saved along with each Effect. You’ll notice that their labeling changes depending on whether or not they are actually doing anything! If the Level parameter for a Mod is set to 00, then every parameter within that Mod is labeled entirely in small letters (because it is disabled). But as soon as you change the Level to something above or below 00, the first letter in each parameter will be capitalized (so “mod1 Level” becomes “Mod1 Level”, etc.). This way you can tell at a glance whether or not a Mod is active, no matter what page you’re on.

A tip: Don’t confuse this Effect Mod function with the Mod settings within the Programs! They are not the same thing, since they have entirely independent destinations. (They can tap the same sources, though. For more information, see *Part 8: Editing Programs*.)

*If you modulate an Effect parameter while audio is passing through it, it is possible that you will generate some degree of distortion in the audio (sometimes known as “Zipper noise”.) There is nothing abnormal or broken about this: it is due to the “stair-step” nature of the modulation source. One exception to this is Chorus Speed, which modulates more smoothly.*

There are six Modulation parameters:

- 1) **Mod1 Source**
- 2) **Mod1 Destination**
- 3) **Mod1 Level** (-99 to 99)
- 4) **Mod2 Source**
- 5) **Mod2 Destination**
- 6) **Mod2 Level** (-99 to 99)

### **MOD1 SOURCE**

**Range of Settings:** (see list below)

**Page 1**

This parameter selects the control source for the first modulation path. The most common controllers appear as direct options in the display. They are:

- Aftertouch
- Mod Wheel
- Pitch Wheel
- MIDI Volume
- Sustain Pedal
- Pedal 1
- Pedal 2
- Controllers A–D

If you want to use a MIDI controller that isn’t listed, select one of the [A-D CONTROLLER] sliders (or one of the Pedals) and then go to Pages 8 through 13 of Global Edit mode to link that mod source to the MIDI Controller number of your choice.

## MOD1 DESTINATION

Range of Settings: (see list below)

Page 2

This is where you select exactly what Effect parameter your modulation source is going to modulate. It's a big list. Not all of these are available in all configurations, but the possible destinations are:

- Pitch Speed
- Pitch Depth
- Pitch Level
- Pitch Balance
- Delay Time
- Delay Feedback
- Delay Level
- Reverb Balance
- Reverb Input
- Reverb Decay
- Reverb Low Decay
- Reverb High Decay
- Reverb Diffusion
- Reverb Level
- Overdrive Threshold
- Overdrive Bright
- Overdrive Balance
- Overdrive Level
- Lezlie Balance
- Lezlie Level
- Lezlie Speed
- Lezlie Motor

If the selected Configuration has a particular effect on more than one Send, certain Mod Destination parameters will be listed more than once. An example: In Config. #1 there is a Delay on each Send, so the Delay Time parameter in this subfunction will appear four times — one for each Send. They are identified by number, like so: **D1 Time**, **D2 Time**, **D3 Time**, and **D4 Time**.

In the case of Pitch, which offers a variety of effect types, different parameters will be available (or unavailable) depending on the effect type chosen.

Note: if the Resonator or Detune effects are chosen as the Pitch Effect, you won't see their parameters listed as Mod destinations. But they're still available to you. For example, if you've chosen Resonator on Send 1 and you want to be able to modulate its first parameter (Resonator Tune), choose P1 Speed as your destination (that's the first parameter you can modulate in a Chorus). The Resonator Decay parameter is its second parameter, so to modulate it you would choose P1 Depth (the second P1 parameter) as the destination. Just remember: the Resonator is a Pitch effect, just like chorusing, flanging, and detuning.



## **MOD1 LEVEL**

**Range of Settings: -99 to 99**

**Page 3**

This decides the degree to which the Destination will be modulated by the selected Source. Please notice the setting range, which allows you to choose both negative and positive numbers. Don't be daunted by that — the way it works is very clear in practice.

Here's an example. Assume that Reverb Decay is the Destination, and Mod Wheel is the Source. In that situation, a positive Level setting would let you increase decay time by moving the Mod Wheel up; while a negative setting would let you *decrease* decay time using exactly the same motion.

## **MOD2 SOURCE**

**Range of Settings: (see list)**

**Page 4**

This works the same as described for **Mod 1 Source**, above, but for the second possible modulation route.

## **MOD2 DESTINATION**

**Range of Settings: (see list)**

**Page 5**

This works the same as described for **Mod 1 Destination**, above, but for the second possible modulation route.

## **MOD2 LEVEL**

**Range of Settings: -99 to 99**

**Page 6**

This works the same as described for **Mod 1 Level**, above, but for the second possible modulation route.

## [70] — LEZLIE (CONFIGURATIONS 3 AND 5 ONLY)

This “spinning speaker” simulation is only available in Configurations 3 and 5. In Configuration #3 it takes its input from Send 1, and has three parameters:

- **Motor** (on/off)
- **Speed** (fast/slow)
- **Horn Level** (-6 to +6 db)

In Configuration #5 it can have up to two inputs, and those can come from a greater variety of sources. Because of that, in this Configuration the Lezlie has three more parameters:

- **Input 1**
- **Input 2**
- **Input Balance**

Note: When you’re in Configuration #3 and you want to modulate the Lezlie speed, you’ll find there’s no parameter for a Mod destination labeled “Lezlie”. But you can still control it by selecting “P1 Speed” as the destination. Configuration #5 *does* have Lezlie parameters at the top of the Mod destination list, however, so be careful! If you modulate P1 Speed in Configuration #5 you’ll be changing the Chorus/Flange speed instead.

### MOTOR

<b>Range of Settings: On/Off</b>	<b>Page 1</b>	<b>Config. 3</b>
	<b>Page 4</b>	<b>Config. 5</b>

This determines whether the Lezlie is operating or not. When turned on, the rotating speaker effect starts up slowly, just like the real thing. When turned off, the effect dies down slowly until it finally reaches a complete stop.

You can control the Motor On/Off setting from a footswitch, if you want. If you haven’t already, you’ll want to read the [60] - MOD section first.

Here’s how to do it: Select the Sustain Pedal as the Mod source and Lezlie Motor as your destination (or “P1 Motor”, depending on the configuration). That part’s simple enough, but the Mod Level setting is crucial in making this work. If the Motor is going to be Off when the Program is first selected, set the Mod Level to +99 (so the footswitch turns the Lezlie on when pressed, and off when it is released). But if the Motor will default to On when the Program is called up, route the footswitch *negatively* in the Mod function. Since the Motor would be already On, a Level of +99 wouldn’t do anything because the Motor can’t be more “On” than it already is! So a Level of -99 would be what you want in this case.

### SPEED

<b>Range of Settings: Slow/Fast</b>	<b>Page 2</b>	<b>Config. 3</b>
	<b>Page 5</b>	<b>Config. 5</b>

This determines the speed at which the rotating effect “spins” when the Program is called up. When you switch between the two speeds, the effect will “ramp” up and down just like the real deal, so any Program which uses “Fast” as the initial setting will start “ramping up” when you first select it. And if you want to be able to control

the Leslie speed when “Fast” is the default, you’ll have to route something *negatively* in the Effects Mod function (see note in previous section).

Note: If you want to know how to control the speed of the Lezlie from the Mod Wheel or some other controller, learn about the Effects Mod function (button [60]). Also, see the note at the top of the Lezlie section regarding controlling Lezlie speed in the various Configurations.

## HORN LEVEL

Range of Settings: -6 to +6 dB Page 3      Config. 3  
Page 6      Config. 5

This parameter provides a way to cut or boost the high frequencies in the Lezlie effect, allowing you to “darken” or “brighten” the tone to suit your music. It works in 1dB increments, over a 12 dB range.

## INPUT 1

Range of Settings: Reverb/Delay Page 1      Config. 5

In Configuration #5, as noted, the Lezlie has two possible input sources. This is one of them. It is limited to one of two settings: Reverb Output or Delay Output.

## INPUT 2

Range of Settings: (see list below) Page 2      Config. 5

This parameter selects the second input to the Lezlie in Configuration #5. It has a wider selection of possible settings than Input 1. They are:

- Sends 1 – 4
- Overdrive Output
- Pitch Input
- Pitch Output
- Delay Input
- Reverb Input

## INPUT BALANCE

Range of Settings: <99 to <0> to 99> Page 3      Config. 5 only

This controls the relative level of Input 1 and Input 2 signals going into the Lezlie.

When set to “<99”, only Input 1 is being routed to the Lezlie. When set to “99>”, all that goes through is Input 2. When set dead-center to “<0>”, an even mix of both signals is passed on.

## [80] — PITCH

This function controls all Effect settings related to pitch. It has many different parameters, and not all of them are available in every Configuration (or even in each Pitch subfunction: Resonator and Stereo Chorus, for example, have completely different structures). Because of this, nearly all of the following parameters show up on different page numbers occasionally. It can be easy to lose your place when you aren't familiar with the different Pitch function settings. Pay close attention to the Configuration maps in this manual as we go through these parameters and you'll be fine.

Note: For the sake of simplicity, we have chosen the most frequently used page numbers for each parameter when discussing them. So if you're looking for one of these parameters and can't find it, use the **[PAGE]** buttons to step one or two pages in either direction and it'll probably be there.

### PITCH TYPE

Range of Settings: (see list below)

Page 1

There are six different Pitch-altering effects. They are:

- Mono Chorus
- Stereo Chorus
- Mono Flange
- Stereo Flange
- Pitch Detune
- Resonator

Pitch effects are achieved by splitting a signal into two parts, delaying and/or changing the pitch of one of the parts, and then mixing the two back together. This final mixing step is essential, since the overall sound of the effect is created in the way the changed and unchanged signals interact.

Although some of these can sound quite similar, depending on their settings, each is achieved differently and will therefore be more (or less) useful depending on the circumstances. Following are some brief explanations which will help you make the choices that are best for your own music.

## MONO CHORUS

The Chorus effect is achieved by taking part of the signal and slightly delaying it, then slightly detuning it as well. This detuning is variable, not steady, because it is being modulated by an LFO (Low Frequency Oscillator). There are many possible adjustments in this algorithm. Some of the more interesting and useful ones include varying the LFO depth, varying the LFO speed, feeding a portion of the detuned signal back into its own input (thus increasing the effect), and changing the LFO waveform from a smooth triangle wave to a more abrupt square wave (causing the detuning to become more pronounced).

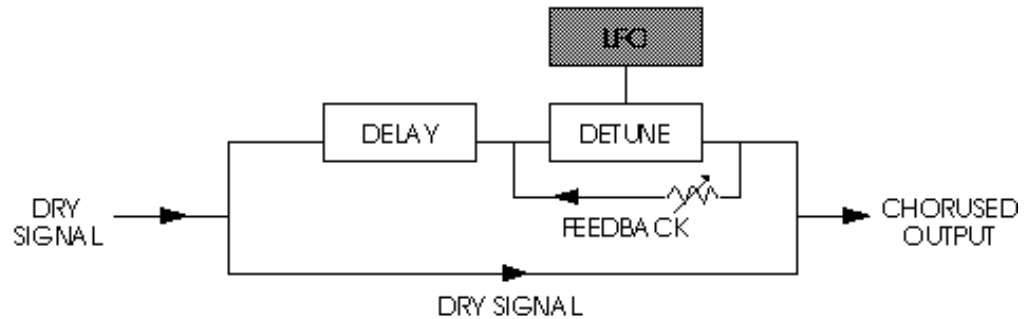

## STEREO CHORUS

In a Stereo Chorus, the signal is split into three parts: a dry signal and separate left and right detunings. Whenever the left channel is detuned sharp, the right channel is automatically detuned flat, and vice versa. This causes the effect to become more pronounced and dramatic while keeping it “in tune” to the ear.

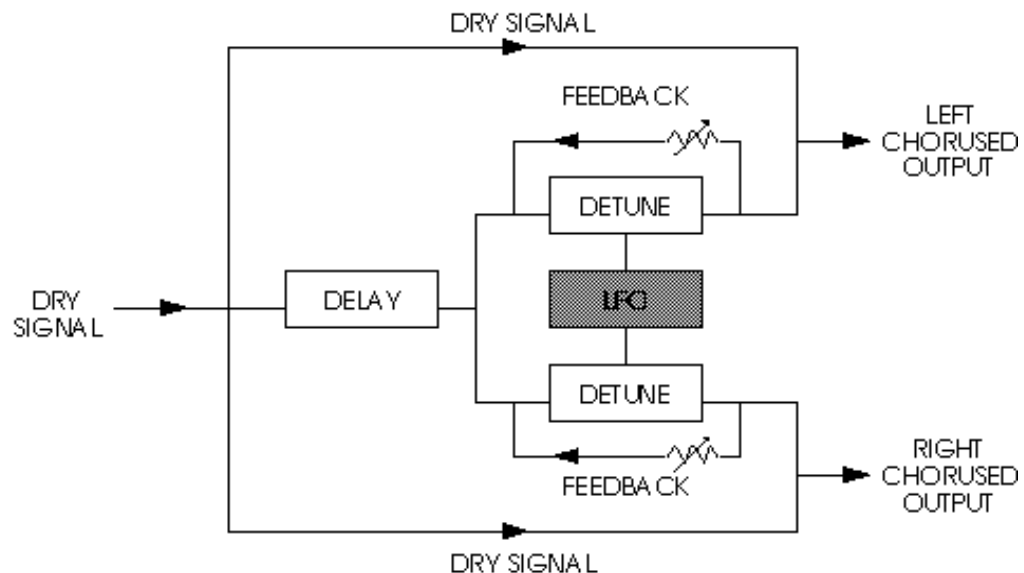

### MONO FLANGE

First used in the 1960s, “flanging” was achieved by using two tape recorders to record and play back the same material at the same time. By alternately slowing down one tape machine, and then the other, an interesting phase cancellation could be generated. There is a much-repeated legend that this slowing down was done by pressing fingertips against the flanges of the tape supply reels, hence the effect’s name. But nobody actually knows for sure.

Flanging is achieved by splitting a signal and giving one part of it a variable time-delay. (This is similar to Chorusing, except here we use the LFO to modulate delay time instead of pitch.) The delayed signal is then mixed back with the original sound to produce that well-known “swooshing” or “doppler tunnel” sound.

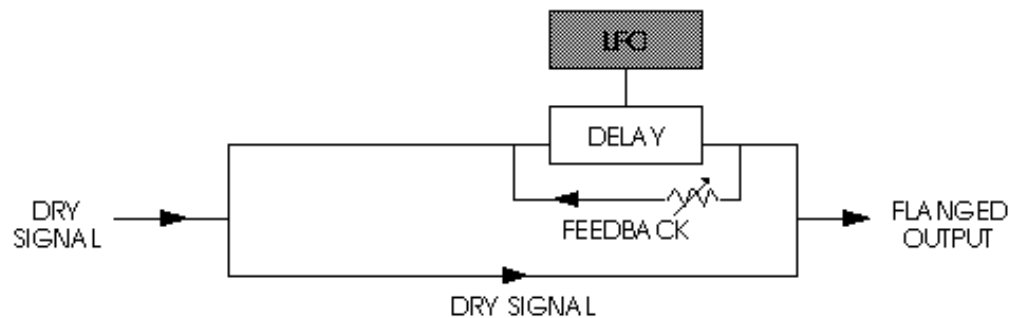

As with Chorusing, the Flanging algorithm offers great things to play with. The speed and depth of the LFO can be varied, and part of the signal can be fed back into itself to make the effect stronger. This feedback setting can be either “Normal” or “Inverted”. Try using “Inverted” for a more dramatic flange.

### STEREO FLANGE

In a Stereo Flange, the signal is split into three parts: a dry signal and separate left and right signals, each with its own delay. While one channel flanges up the other channel automatically flanges down, making the effect more pronounced.

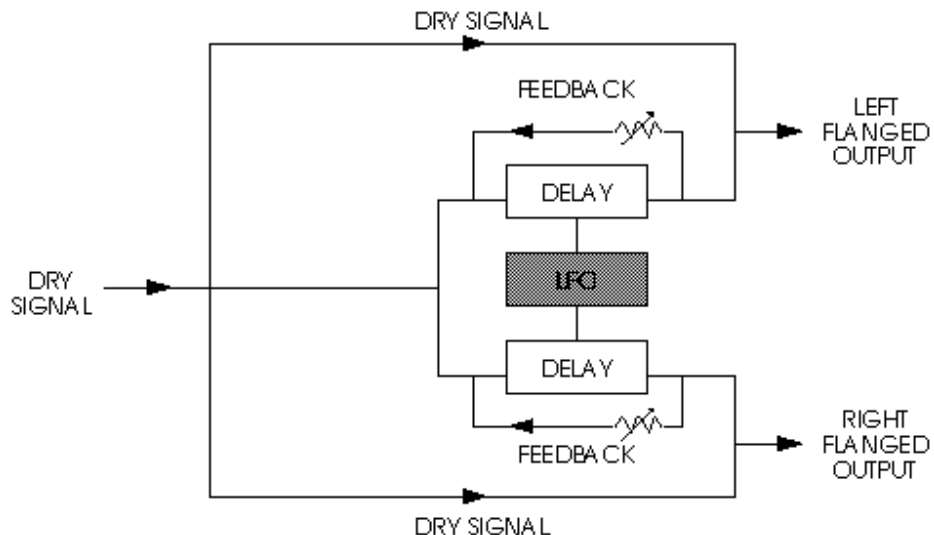

### PITCH DETUNE

As its name implies, Pitch Detune takes a part of the signal and detunes it either sharp or flat. When mixed back with the original dry signal, the popular “12 string guitar” effect is produced, thickening the sound.

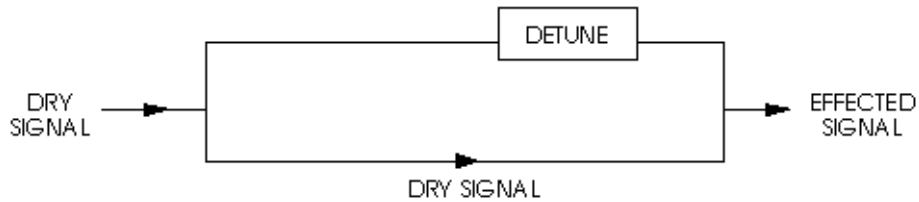

### RESONATOR

This can be thought of as a highly resonant filter — or a filter that is tuned to a specific frequency with a lot of emphasis — which causes the frequency at which the resonator is set to be *highly* accentuated. This is useful for creating a brighter, buzzier, edgier sound.

Note: when you want to control the Resonator’s output level on the Mix button [120], adjust the Pitch effect level for that Send.



## DELAY INPUT LEVEL

Range of Settings: <99 to <0> to 99>

Page 2 (Config. 2 only)

This parameter is only available on Send 1 in Configuration #2. It adjusts the level of the signal running from the Delay output to the Pitch Input.

*If the chosen Pitch type is Mono Chorus, Stereo Chorus, Mono Flange, or Stereo Flange, then Page 2 through Page 5 of the Pitch function will contain the following four parameters:*

## WAVEFORM SHAPE

Range of Settings: Sine/Square

Page 2

This determines the LFO's waveform shape. This parameter only appears when the Mono or Stereo Chorus or Flange are selected. The Waveform Shape of the LFO can be changed from a sine waveform, which provides a smoother, more even sound, to a square waveform, which makes the Chorus or flange effect more pronounced.

## SPEED

Range of Settings: 00 to 99

Page 3

This parameter adjusts the LFO Speed of all Pitch types, with the exception of Pitch Detune and Resonator.

## DEPTH

Range of Settings: 00 to 99

Page 4

This parameter adjusts the LFO Depth of all Pitch types, with the exception of Pitch Detune and Resonator. The LFO Depth, which is the amount of pitch alteration, can be adjusted to produce the desired effect.

## FEEDBACK

Range of Settings: 00 to 99

Page 5

This parameter adjusts the LFO Feedback of all Pitch types, with the exception of Pitch Detune and Resonator. A portion of the output of the Pitch section can be "fed back" into the input in order to make the effect more tonal or pronounced.

*The following three parameters only appear if the Pitch type is set to Pitch Detune or Resonator, respectively.*

## DETUNE

Range of Settings: -99 to +99

Page 2 (Pitch Detune only)

If the Pitch type is Pitch Detune, page 2 will have only this parameter. This adjusts the tuning of the Pitch Detune effect. This can be set between -99 and +99, in 1 cent increments.

## RESONATOR TUNING

Range of Settings: 00 to 60

Page 2 (Resonator only)

If the Pitch type is Resonator, page 2 of the Pitch function will let you adjust the Resonator tuning. This can be tuned from 00 to 60.

Note: This parameter shows up on Page 1 for Send 3 of Configuration #3, and Page 4 for Send 1 of Configuration #5.

## RESONATOR DECAY

Range of Settings: 00 to 99

Page 3 (Resonator only)

If the Pitch type is Resonator, page 3 will let you adjust the Resonator Decay. This can be set 00 to 99, whereby 00 is a very fast decay and 99 is a very slow decay.

Note: This parameter shows up on Page 2 for Send 3 of Configuration #3, and Page 5 for Send 1 of Configuration #5.

## INPUT 2

Range of Settings: Sends 1 – 4

Page 2 (Config. 5 only)

This parameter selects the second input to the Resonator in Configuration #5. If you look closely at the Configuration diagram, you'll see that Input 1 is hardwired to the Overdrive. The balance between the two Inputs is set by the Input Balance parameter (see below).

## INPUT BALANCE

Range of Settings: OVR<99... to <0> to ...99>IN2 Page 3 (Config. 5 only)

Take a deep breath!

This shows up in the display as “->Pch: OVR <0> IN2”. That seems cryptic, so let's work through it from left to right. The right-pointing arrow (->) stands for “The Input To...” (we can only cram so many characters in the display, so we had to get creative with this one). “Pch” stands for “the Pitch Effect”, which is what type of effect the Resonator is. Everything to the right of the colon (:) is a value. So the screen thus far would read, “The Input To the Pitch Effect has a value of...”.

The rest is easy: When set to “<99>”, only the Overdrive is being routed to the Resonator. When set to “99>”, all that goes through is Input 2. When set dead-center to “<0>”, an even mix of both signals is passed on.

Now, that wasn't so bad, was it?

## [90] — DELAY

The Delay function is used to edit Delay parameters. The QS's effects processor has three different Delay types available.

**Note:** Some Configurations only have a mono Delay on some Sends, and when this is the case the Delay Type parameter will be unavailable. Instead, the parameters normally found on page 2 of the Delay function are shown in page 1, and the other pages also drop by one number (please refer to next section for a description of those parameters). The exceptions to this are the Mono Delays on Send 4 of Configurations 1 and 3, and the Mono Delay on Send 1 of Configuration #2. These Delays have no Input Balance parameter (they don't need them), so all of their parameters are offset by 2 instead of by 1 (Delay Time is found on pages 1 and 2, instead of pages 3 and 4. Feedback is found on page 3, not page 5).

### DELAY TYPE

Range of Settings: (see below)

Page 1

**Ping-Pong.** This is called a "Ping Pong Delay" because the output bounces from side to side (left to right) in stereo with the speed determined by the delay time. The maximum delay time is 399 milliseconds.

**Stereo Delay.** The Stereo Delay is actually two separate delays, which can be individually varied. The maximum delay time for each delay is 399 ms.

**Mono.** The Mono Delay has the advantage of twice the available delay time, or 799 ms in Configuration #1, 1199 ms in Configuration #2.

*In Pages 2 through 5 of the Delay Function you will find the remaining parameters for the Delay function. If the Stereo Delay type is selected, you'll be able to select an additional set of pages (6 – 8) with the [PAGE] buttons. The extra pages are due to the fact that the Stereo Delay type has parameters for both the Left and Right channels.*

### INPUT

Range of Settings: <99 to <0> to 99>

Page 2

This parameter is used to balance the Delay Input between the signal coming from the Pitch effect output (if applicable in the selected Configuration) and the dry effect send.

### TIME

Range of Settings: 0 to 1199ms

Pages 3 & 4 (and 6 & 7 in Stereo Delay)

This is the actual Delay time, which determines the amount of time the input signal will be delayed. The Stereo and Ping Pong Delay types can have a delay time of up to 399ms. However, the Mono Delay can have up to 799ms per channel (1199 ms in Configuration #2). Use Page 3 to adjust the delay time in 10 ms intervals; use page 4 to adjust the delay time in 1 ms intervals. When using the Stereo Delay, pages 3 & 4

let you adjust the delay time of the left channel, while pages 6 & 7 let you adjust the same for the right channel.

## FEEDBACK

Range of Settings: 00 to 99

Page 5 (and Page 8 in Stereo Delay)

This adjusts the Delay Feedback, which is a portion of the delay signal output being “fed back” into the input. This results in the delay repeating itself. The higher the feedback value, the more repeats you’ll get. When using the Stereo Delay, page 5 lets you adjust the feedback level of the left channel, while page 8 lets you adjust the same for the right channel.

## [100] — REVERB

Reverb can be thought of as a great number of distinct echoes, called reflections, that occur so fast that our ear hears them blurred together as one. In nature, different-sized spaces give distinctly different sounding reverbs, depending on the size and shape of the space, and the texture of surfaces that the reflections bounce off of. The various parameters in the effects processor make it possible to simulate nearly any natural reverberant space that can be imagined, and a few artificial ones as well.

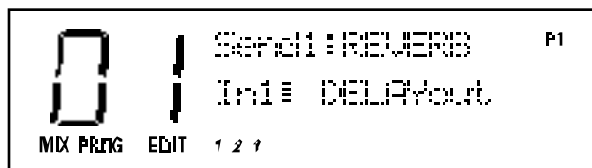

The Reverb function is used to edit Reverb input levels and other parameters. In all configurations, page 1 of the Reverb function selects what the reverb is “hearing” (i.e., where the input of the reverb is coming from). The source can come directly from the Effect bus, the output of other effects in the chain before it, or a mix of several of them. *Example:* In Configuration #1 on Send 1, page 1 of the Reverb function (shown above) allows you to select the first of two sources to be routed to the reverb’s input. You can choose either the output of the Delay or the output of the Pitch effect as Input 1. In page 2, you can choose the second input for the Reverb, which can be the dry Send 1 signal, the Delay input or the Pitch output. You can then adjust a balance between these on page 3 and set an overall input level on page 4.

### A Note regarding Configuration #2 and the Reverb function

The parameters and pages in the Reverb function are identical in every Configuration but #2. Configuration #2 is different in that it only has 11 pages of parameters for each of its two Reverbs as opposed to the 14 pages of parameters available to the Reverbs in the other Configurations. The differences are due to the smaller number of input choices the Reverbs have in this Configuration. So what you’ll find here is something akin to what was described regarding the various Mono Delay parameters: the page numbers are going to be off by 3 for the parameters of the Reverbs in Configuration #2. So if you’re looking up the Diffusion parameter in the manual and it says it’s on Page 14, you should expect to find it on page 11 for the Reverbs in Configuration #2.

### **...and one regarding the Reverb function and Sends 2 through 4**

If Configurations 1 or 3 are selected and you press [10] to select Effect send 2, you will see the various parameters that deal with the amount and type of signal going into the Reverb from Send 2. Note that there are now only 4 pages available, since the actual parameters for editing the Reverb itself are found back on Effect send 1.

Press [20] to select Send 3 and you will have the same options that you had for Effect send 2, but now the parameters adjust the amount and type of signal going into the Reverb from Send 3.

If you press [30] to select Send 4, you will have only two pages available. Page 1 controls the Balance between the Delay output and the dry Effect send signal, while page 2 controls the overall input level to the Reverb.

The situation is similar for the other Configurations: on Sends 2 through 4 you will have the ability to adjust only what those Sends will be sending into the shared Reverb, not the Reverb itself. (Naturally, Configuration #2 is the exception again, since it has a separate Reverb available for Sends 3 and 4.)

And remember that some Configurations don't use some Sends, so you won't see any parameters related to Reverb there.

*The next three parameters are not available in Configuration #2:*

## **INPUT 1**

**Range of Settings: Delay Out/Chorus Out      Page 1 (Config. 1, 3, 4 and 5)**

In Configurations 1 and 3, there are two inputs to the Reverb. Both Inputs 1 and 2 can select a signal from several locations in the signal chain. You can select either the Pitch output or the Delay output as Input 1. If the Pitch output is chosen, the signal going into the Reverb will be chorused, flanged, detuned or resonating, depending upon which Pitch type is selected. If the Delay output is chosen, note that the signal which reaches the delay may already have passed through the Pitch module, depending on the Input Balance settings of the Delay module.

## **INPUT 2**

**Range of Settings: Pitch Out/Delay In/Send      Page 2 (Config. 1, 3, 4 and 5)**

Input 2 can have as its source either the Pitch output, the Delay input, or the dry Effect send signal. If the signal is taken from the Delay Input (which is a point *after* the Delay Input Balance), then the signal will be a blend between the Pitch Output and the dry Send. If the signal is taken from the Pitch output, the signal going into the Reverb will be chorused, flanged, detuned or resonating, depending upon which Pitch type is selected. If the signal is taken from the Effect send, the Reverb will receive direct, unaffected signal.

## **INPUT BALANCE**

**Range of Settings: <99 to <0> to 99>      Page 3 (Config 1, 3, 4 and 5)**

This allows you to control the balance between Reverb Inputs 1 and 2 and therefore control the blend between the various input sources. This makes it possible to have the signal come into the Reverb from the Pitch section, the Delay section, or the direct Effect send in any combination or amount.

The next parameter is available on all other Configurations, but only on Sends 2 and 4 in Configuration #2:

## REVERB INPUT LEVEL (SEND 1)

Range of Settings: 00 to 99

Page 4 (Config 1, 3, 4 and 5)

This parameter controls the overall Input Level going into the Reverb for Send 1. The signal it sends is based upon the Balance between the selected Inputs to the Reverb (if more than one Input was available).

## REVERB INPUT LEVEL (SENDS 2 THROUGH 4)

Range of Settings: 00 to 99

Page 4 (Sends 2 and 3)

Page 2 (Send 4)

This parameter controls the overall Input Level going into the Reverb for Sends 2 through 4. The signal it sends is based upon the Balance between the selected Inputs to the Reverb (if more than one Input was available).

Note: Naturally, Configuration #2 just *had* to be different. If it is the active Configuration and you press [10] to select Send 2 from within the Reverb function, you'll wind up on page 1 and the display will look like this:

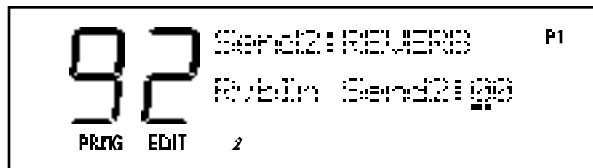

There is only one page available to you here. It lets you adjust the level of the signal going from Effect send 2 into the Reverb. Send 2 in this Configuration has no effects of its own, and is intended to be used for signals you want sent directly to Reverb 1 without running them through Delay 1 and Pitch 1 first.

Send 4 is similar to Send 2 in this Configuration, in that it has no effects of its own but serves as a bypass going directly to Reverb 3.

The next parameter is only available in Configuration #2 on Sends 1 and 3:

## CHORUS INPUT LEVEL

Range of Settings: 00 to 99

Page 1 (Config 2 only, Sends 1 and 3)

If Configuration #2 is selected (refer to block diagram of Configuration #2, earlier in this chapter), the first page of Send 1's Reverb function will look like this:

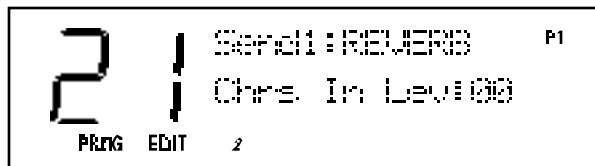

There is a unique parameter on this page: Chorus Input Level. It lets you adjust the level of the signal coming from the Pitch output going into the Reverb; otherwise the signal comes purely from the Pitch input. (Note that the signal which reaches the Chorus may already have passed through the Delay module, depending on the Input settings of the Chorus.)

The only difference for Send 3 is that it has no Delay ahead of the Chorus. Otherwise it functions exactly the same as Send 1 in Configuration #2.

*The rest of these parameters are common to all Reverbs in all Configurations (except as noted):*

## REVERB PARAMETERS

Use the [PAGE▶] button to advance the display through the remaining pages of the Reverb function. But don't forget that you must also have the correct Effect send selected in order to get at the Reverb parameters. Just a reminder: in Config. #1, they are found only on Effect send 1; in Config. #2, they are found on Sends 1 and 3 (since there are two separate Reverbs).

Here are the parameters you will find on these pages:

### REVERB TYPE

Range of Settings: (see below)

Page 5

The QS has seven different reverb types, all stereo, each of which simulates a different space or produces a different ambient effect. The different Reverb types are:

**Plate 1 & 2.** The two Plate reverb types simulate an artificial device known as a Plate. In the early days of recording, Plates were extremely popular because they were almost the only way to provide any sort of artificial ambiance to a recording. The sound of a well-tuned Plate has become quite popular over the years, especially when used on vocal or drum sounds. The tonal characteristics of these two Plate reverbs differ subtly in ways similar to different manufacturers' plate reverbs.



**Room.** The Room reverb type simulates not only rooms of different sizes, but rooms with different surface materials. A room with soft surfaces such as carpet will produce a reverberant sound with much less high end (treble) than a room with hard surfaces. This reverb type can easily simulate both examples and many, many more.

**Hall.** Much larger than a room, Halls are characterized by their high ceilings, irregular shapes, and generally uniform density of reflections.

**Large.** Much larger than a hall, this reverb type emulates the large ambient spaces found in amphitheaters, gymnasiums, etc.

**Gate.** Gated Reverb is a very popular effect on drums first found on English records in the early 1980s. This reverb type can simulate applying a noise gate (a device that automatically decreases the volume once the signal falls below a certain level) across the output of the reverb thereby causing the initial attack of the reverb to sound very big, but the tail of the reverb to be cut off very quickly. Although this effect is not found in nature, it works great for modern drums, percussion, and any quickly repeated, transient source.

**Reverse.** The Reverse Reverb type is an inverted reverb in which the volume envelope is reversed. This means that the signal begins softly but grows louder until it is cut off, rather than loud to soft as normal.

## **PRE-DELAY TIME**

**Range of Settings: 0 to 299ms**

**Pages 6 & 7**

Pre-Delay is the slight delaying of the Reverb itself so that the dry signal more easily stands out from the Reverb. A bit of Pre-Delay can sometimes make certain instruments (such as snare drums) sound bigger. Use page 6 to adjust the Pre-Delay Time in 10ms intervals, and/or use page 7 to adjust the Pre-Delay Time in 1ms intervals. This Pre-Delay is part of the Reverb itself; don't confuse it with the separate Delay modules available under the Delay function.

## **PRE-DELAY MIX**

**Range of Settings: IN<99DEL to IN99>DEL**

**Page 8**

This parameter allows you to control the balance between the Pre-Delayed signal of the Reverb and the straight Reverb itself. It gives you the ability to hear a bit of the Reverb before the loudest part of the Reverb (the Pre-Delayed Reverb) sounds, which makes for bigger and smoother sounding Reverb settings. When this is set to <99 you get the Reverb signal with no Pre-Delay, while a setting of <0> gives an even mix and a setting of 99> gives you pure Pre-Delayed reverb.

## **INPUT FILTER**

**Range of Settings: 00 to 99**

**Page 9**

This parameter adjusts the frequency of the low-pass filter which affects the audio before it reaches the Reverb input. Lower values remove high frequencies from the input signal, which is what to do if you want to make the Reverb effect less bright.

## DECAY

Range of Settings: 00 to 99

Page 10

The Reverb Decay determines how long the Reverb will sound before it dies away. When using the Reverse Reverb type, Reverb Decay controls the Reverse Time.

## LOW DECAY/ HIGH DECAY

Range of Settings: 00 to -99

Pages 11 & 12

These two parameters allow the Decay Time to be set separately for both the low and high frequencies of the Reverb. This means that you have control over the tonal shape of the Reverb itself, being able to make the high frequencies die faster if the effect is too bright, and being able to make the lows die faster if the effect is too boomy. With these parameters you can simulate different surfaces of a room or hall, with softer surfaces absorbing more high frequencies and smaller rooms having faster low frequency decay.

Note: If the selected Reverb type is Gate or Reverse, the Low Decay parameter is unavailable (leaving only 13 pages of Reverb parameters available [10 in Config #2]).

## DENSITY

Range of Settings: 00 to 99

Page 13 (Page 12 if Gated or Reverse type)

Density controls how the first reflection of the reverb effect will appear. When set to 0, the first reflection is heard alone without any other reflections. When set to 99, the first reflection appears to “fade-in” and then “fade-out”. This is because a number of reflections will occur just before and just after the first reflection, in addition to the remaining reflections heard after the first reflection; the reverb sounds more “dense”.

Note: If the select Reverb type is Large, the Density parameter is unavailable (leaving only 13 pages of Reverb parameters available [10 in Config #2]).

## DIFFUSION

Range of Settings: 00 to 99

Page 14 (Page 13 if Gated or Reverse type)

Diffusion determines the “thickness” of the reverb sound by adding more reflections to the reverb’s decay. With lower diffusion settings, you may be able to actually hear the individual echoes that make up the overall reverb sound. With higher diffusion settings, the echoes increase in number and blend together, washing out the reverb’s decay. Greater diffusion works better with percussive sounds, whereas less amounts of diffusion work well with vocals and other sustained sounds.

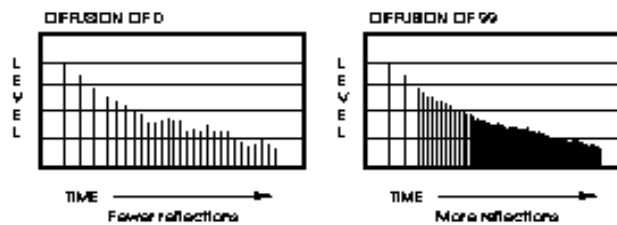

*Note:* Each graph above assumes a Density setting of 0 so as to better illustrate the Diffusion parameter.

## [110] — **OVERDRIVE (CONFIGURATION 5 ONLY)**

The Overdrive effect provides four parameters spread across four editing pages. It is only used in Configuration #5.

### **OVERDRIVE TYPE**

Range of Settings: Hard or Soft

Page 1

The Soft Overdrive has less gain and provides slightly less distortion than the Hard Overdrive. Another difference is that the Hard setting will only provide distortion when the signal feeding the Overdrive effect is above the Overdrive Threshold setting (see below). However, with the Soft setting there will still be a slight bit of distortion if the signal is below the Overdrive Threshold setting.

### **OVERDRIVE THRESHOLD**

Range of Settings: 00 to 99

Page 2

This parameter sets the level which the signal must reach before the Overdrive effect will begin distorting. But it works differently than you might expect: A higher value means a lower Threshold. So with a high number, it doesn't take much input before the Overdrive effect will start to distort. When set to a low number, the distortion will not occur until the signal becomes louder than the Threshold setting.

### **OVERDRIVE BRIGHTNESS**

Range of Settings: 00 to 99

Page 3

This parameter sets the tone of the Overdrive effect. Higher numbers result in a brighter sounding overdrive. Lower numbers result in a duller distortion sound.

### **OVERDRIVE BALANCE**

Range of Settings: CLN<99>OVDR to CLN99>OVDR

Page

4

This controls the output mix of the Overdrive effect. When set to "<99", the Overdrive effect cannot be heard at all. When set to "<0>", you have an even mix between the original, unaffected signal and the overdriven signal. When set to "99>". only the overdriven effect is heard.

## [120] — EFFECT MIX

Not to be confused with an actual Mix or Mix mode, the Effect's Mix function is where you can mix the various signal levels of all the effects to the Main Left and Right outputs of the QS. Each Effect send has a separate Mix page for any effect module that feeds the main outputs. If an Effect send has no effect modules due to the Configuration, or if a particular Effect module isn't available on that Send, you'll see the message NOT IN CONFIG.

Note that the Mix page doesn't control how much the individual effect modules feed to each other; only how much they feed to the Main outputs.

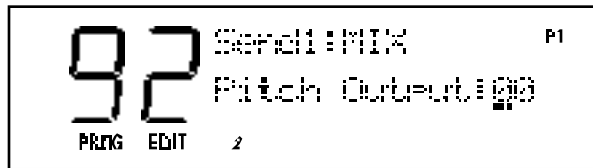

This is what you'll see on page 1 of the Mix function for Send 1 in Configurations 1 and 4. Depending on the selected Configuration and Send, you may see something different on page 1. This is because the order and availability of the effects differs from one Configuration to the next. For example: for Send 1 in Configuration #1, the order reads Pitch, Delay, Reverb; but in Configuration #2, the order of effects for Send 1 is Delay, Pitch, Reverb.

### PITCH LEVEL

Range of Settings: 00 to 99

Page 1    Config. 1 and 4

Page 2    Config. 2 and 5

Adjusting this value will cause the Pitch Output Level for that Send to increase or decrease. Even if this parameter is set to 00, the output of the Pitch section can still feed other Effect modules (depending on the Configuration).

### DELAY LEVEL

Range of Settings: 00 to 99

Page 2    Config. 1, 3, 4

Page 1    Config. 2

Page 3    Config. 5

Adjusting this value will cause the Delay Output Level for that Send to increase or decrease. Even if this parameter is set to 00, the output of the Delay section can still feed other Effect modules (depending on the Configuration).

## REVERB LEVEL

Range of Settings: 00 to 99

Page 3     Config. 1, 3, 4

Page 3 (Send 1) Config. 2

Page 1 (Send 3) Config. 2

Page 4             Config. 5

Adjusting this value will cause the overall Reverb Output Level to increase or decrease.

Note: If you pull this parameter down, you will be taking down the reverb for *all* of the sends at once (except for Configuration #2, which contains two separate Reverb effects). This means you won't be able to hear Reverb regardless of how much input you feed it from any of the effect buses.

So if you want to pull down the Reverb level for Send 1 without affecting the other sends, press the Reverb button [100] and use the [PAGE] buttons to find the RvbIn Level parameter (page 4 in most Configurations). This controls the amount of Send 1 which gets fed to the Reverb (and it's quicker than going back to Program Edit mode or Mix Edit mode and editing the Effect Send levels of however many Sounds or Programs may be feeding Send 1). This is also the function you would use to set each of the other Sends' levels to the Reverb.

See pages 91 and 92 for further discussion regarding setting the Reverb Input Level for Sends 2 through 4.

## LEZLIE LEVEL

Range of Settings: 00 to 99

Page 1             Config. 3

Page 5             Config. 5

This parameter is only available in Configurations 3 and 5. Adjusting this value will cause the Lezlie Output Level to increase or decrease.

Note: In Configuration #3 if this parameter is set to 00, the output of the Lezlie effect can still feed the Delay and Reverb modules.

## OVERDRIVE LEVEL

Range of Settings: 00 to 99

Page 1     (Config. 5 only)

Adjusting this value will cause the Overdrive Output Level to increase or decrease. Even if this parameter is set to 00, the output of the Overdrive can still feed other Effect modules in this Configuration.

## PART 7

# EDITING MIXES

## WHAT IS A MIX?

Mix Mode is one of the most powerful features of the QS7.1/QS8.1. Although in Program Mode you can play only one Program at a time, in Mix Mode you can play up to 16 Programs at once, either from the keyboard (as layers or splits) or from an external sequencer (via 16 MIDI channels) or a combination of both.

With Mix Mode, you can do the following:

- Combine (“stack” or “layer”) different Programs so they can be played simultaneously from the keyboard. For example, stack a piano on top of a brass sound and a string sound, adjusting the volume of each for a desirable mix. (Note that the stacking of Programs in Mix Play Mode will impact polyphony according to the total number of Sounds that may be stacked in the four sound layers of each Program.)
- Split the keyboard into different zones--for example, the classic bass guitar on the left-hand side of the keyboard, and synth or piano on the right. You can split the keyboard into as many as 16 zones, which may overlap.
- Use the QS as a master MIDI keyboard. It can transmit on as many as 16 different MIDI channels simultaneously, and send MIDI volume and panning information to each channel.
- Receive up to 16 MIDI channels from an external sequencer, with each channel representing a different instrument--piano on Ch. 1, bass on Ch. 2, drums on Ch. 10, trumpet on Ch. 16. Mix Play Mode is the multitimbral mode of the QS.
- Set the level, panning, transpositions and effect send of each MIDI channel.

## POLYPHONY IN MIX PLAY MODE

The QS has 64-voice polyphony. In Mix Play Mode, if you have all 16 MIDI channels assigned to the same keyboard range, and each channel’s Program has only one active Program Sound, you’ll have 4-note polyphony as you play the keyboard (but a really thick layer...). This is extreme, of course, but should tell you what you can expect when you really pile on the layers from the keyboard. And of course, polyphony will be reduced in this example if one or more of the Programs uses more than one Sound each.

## PROGRAM ASSIGN FOR EACH MIDI CHANNEL

Once a Mix is recalled, you will likely want to choose different Programs than the ones the Mix has stored with it. *This does not require that you be in Mix Edit Mode.* Assigning Programs to the 16 channels of a Mix is done by first using the [◀ PAGE] and [PAGE ▶] buttons (which are also labeled [MIX CHANNEL PROGRAM SELECT]) to select a channel and then using the [0] – [9] and [00] – [120] buttons to select a Program. If desired, you can use the [◀ BANK] and [BANK ▶] buttons to select a Program from any of the internal or card banks.

## MIX EDIT MODE

Editing a Mix begins with using the [◀ PAGE] and [PAGE ▶] buttons to select the MIDI channel you want, and selecting a Program number for each of the channels you want to use (as described above). Beyond Program selection, you may control many other aspects of a Mix by accessing Mix Edit Mode. This is done by pressing the [EDIT SELECT] button while Mix Play Mode; the word "EDITED" should appear in the lower left section of the display, across from the word "MIX":

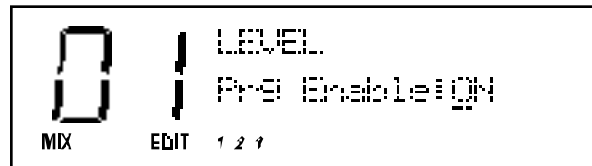

Once in Mix Edit Mode, use the [0] - [9] and [00] - [50] buttons to select a MIDI channel to edit (1 – 16). Use the [60] – [120] buttons to select a Function Group (Level, Pitch, Effect, etc.) If a Function Group has more than one parameter, use the [◀ PAGE] and [PAGE ▶] buttons to locate a specific parameter. The Mix Edit functions and Channels are written in blue above or below each numbered button, on the line labeled MIX.

Each channel of a Mix may be enabled or disabled, without changing any of its parameter settings. When a channel is disabled, its channel number will not appear in the lowest line of the display (unless you have selected it for editing, in which event it will be flashing). You can set levels, panning, effect levels and bus assignments, pitch transposition, keyboard ranges (if making a split or layer), and MIDI parameters for each individual channel. Mix Edit Mode is also where you select which Program's effects will be used for the entire Mix (more on that later).

Here is a simplified diagram of the signal path in Mix mode.

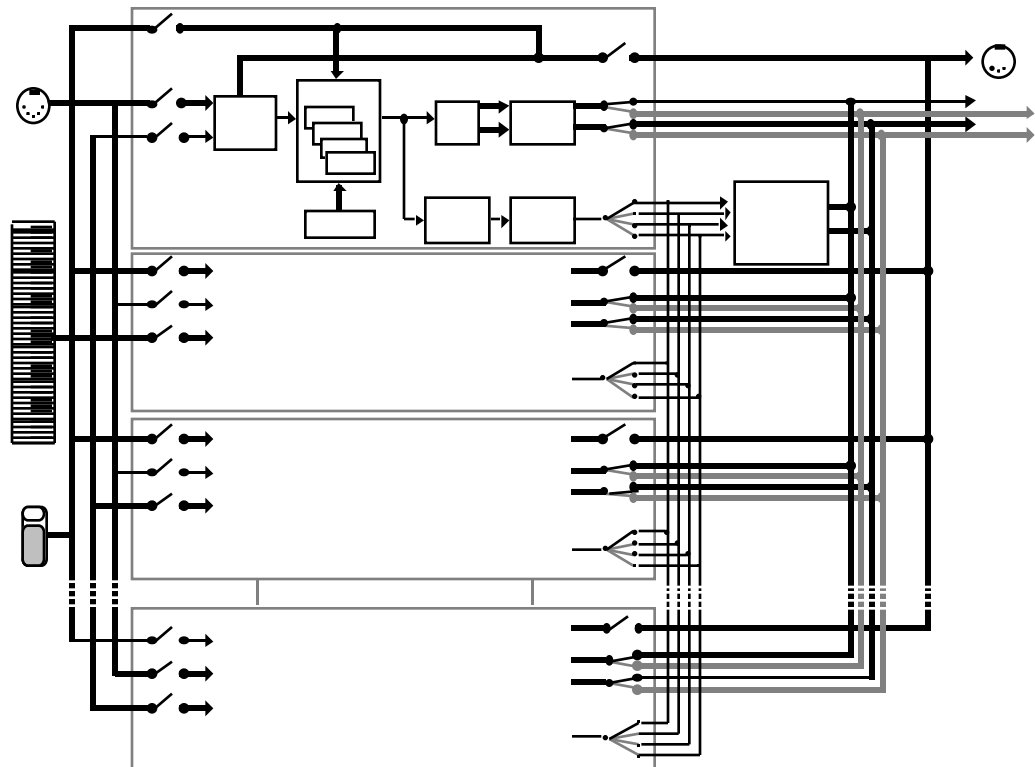



## UNDERSTANDING THE EDIT BUFFERS

In Mix mode, there are 16 edit buffers for the Programs inside the Mix (one for each channel), plus another buffer for the Mix parameters (Level, Pitch, Range, etc.), and yet another buffer for the Effects Processor. When you select a Mix from memory, it is copied into the Mix Edit buffer, the 16 Programs of that Mix are copied into the 16 edit buffers, and the Effect from one of the 16 Programs is copied into the Effects buffer. If you make changes to the Mix, they are only temporarily kept in the edit buffer until a new Mix is selected from memory. Therefore, you **MUST** store your edited Mix if you want to keep it.

In the course of making a Mix, you can enter Program Edit mode (by pressing [EDIT SELECT] a second time) and edit one or more Programs in the Mix. The edits you make are entered into a separate buffer for each Program in the Mix. Note, however, that you **DO** have to *store* each edited Program into the User bank or to a Card bank somewhere before selecting a different Mix, or your changes will be lost. The same goes for editing the Effects Patch, which will need to be stored somewhere (along with its associated Program) before you switch Mixes. If you select another Mix before storing, your changes will be lost.

**TIP:** *Now that we're about to cover the various parameters in Mix Edit mode, don't forget the "Double-button push" trick! This is where you push both of the [VALUE] buttons or both of the [PAGE] buttons at the same time as a shortcut. See Part 4: Basic Operation on page 35.*

## LEVEL SETTING FOR EACH PROGRAM

The Level function (press [60]) of Mix Edit is used to control several parameters that deal with the audio output of the selected channel. Parameters in the Level Function's group include: Volume, Pan, Output, Effects Send Level, Effects Bus and Program Enable.

### Enable (On or Off)

Page 1

This determines whether the selected channel is enabled or disabled. When disabled, no sound will be heard. The Channel indicator in the display for a disabled channel will not appear.



*When you start to setup a MIX, it may be confusing if many of the channels have their Keyboard parameter turned off. In order to hear anything on a particular channel, enable Keyboard control and set the Range so that the low note and high note values are set beyond where you want to play (see pages 38 & 40).*

### Volume (00 to 99)

Page 2

This sets the overall volume for a channel. Higher numbers give higher levels.

### Pan (<3 to 3>, or PROG)

Page 3

This determines the pan position of the selected channel. When set to PROG, the Pan setting will be that stored with the Program assigned to the selected channel (which can be different for each Sound within the Program). However, you can override this setting by selecting a different value, which forces all four Sounds within the Program to be in the same position in the stereo field.

### Output (Main, Aux, Off, or PROG)

Page 4

This determines the audio output assignment for the selected channel. When set to PROG, the channel will use the Output assignments of each Sound within the Program. However, you can override these assignments by setting this parameter to something different. To send the output of all four Sounds to the Main outputs, select MAIN. To send the Program's dry signal to the Aux Outputs, select AUX. When set to OFF, the channel will not be sent to any of the outputs (but can still feed an effect bus).

For information on setting up four discreet Outputs, see the Tip on page 119.

### Effect Level (00 to 99, or PROG)

Page 5

This determines the amount of signal from the selected channel that will be sent to the effects, using one of the four effects buses as determined by the Effect Bus parameter (see below). When set to PROG, the effect level will be that stored by the channel's Program as it was set for each Sound. Any other setting will send each Sound in the Program to its bus at that level.

### Effect Bus (1, 2, 3, 4, or PROG)

Page 6

This determines which effect bus the selected channel will be routed to. When set to PROG, the effect bus assignment will be that stored by the channel's Program. 1, 2, 3 or 4 overrides the Program's bus assignment, sending all sound layers of the Program to the chosen bus.

## PITCH

The Pitch function (press [70]) lets you transpose a channel's Program in either semitone or octave increments.

### **Tune Octave (-2 to +2 octaves)**

**Page 1**

This transposes the Program's pitch in octave (12 semitones) steps from -2 (transposed down 2 octaves) to +2 (transposed up two octaves).

### **Semitone (-12 to +12 semitones)**

**Page 2**

This transposes the Program's pitch in semitone steps, from -12 (transposed down one octave) to +12 (transposed up one octave).

*Note: You can combine these two parameters for an effective transposition range of +/- 3 octaves.*

*Another Note: You can alter the MIDI note numbers being sent to external devices if Keyboard and MIDI Out are set to OFF (see KEYBOARD/MIDI, dead ahead). Also, see Part 5: MIDI for more information.*

## EFFECT

The Effect function (press [80]) is where you select what Effect Patch will be used by the Mix. In Mix Mode, you can have only one Effect Patch per Mix, which will be the Effects Patch associated with one of the Programs used in the Mix.

### **FX Program Change (On or Off)**

**Page 1**

This determines whether the Effects settings will change along with its Program, if a MIDI program change is received on the Effect Channel (see next section). If ON, and a MIDI program change is received, a new Program will be recalled along with its associated Effect Patch. This, however, can change the way the other Programs in the Mix sound, since they all share the same Effects Patch. If you want to recall Programs via MIDI program changes, but also want to continue using the same Effects Patch, leave this parameter turned OFF.

### **FX MIDI Channel (1 to 16)**

**Page 2**

The Effect Channel determines which channel within the Mix will have its Program's Effect Patch used by the entire Mix. In other words, when the Effect Channel is set to 3, the Mix will use the Effect Patch which is contained in the Program assigned to channel 3.

## **KEYBOARD/MIDI**

The Keyboard /MIDI Function (press [90]) allows you to turn on and off the MIDI and Keyboard settings for the selected MIDI channel.

### **MIDI Input (On or Off)**

**Page 1**

This determines whether the selected channel will respond to incoming MIDI messages.

### **MIDI Output (On or Off)**

**Page 2**

This determines whether or not the selected channel will transmit MIDI messages.

### **Keyboard (On or Off)**

**Page 3**

This determines whether or not the selected channel will be playable from the keyboard of the QS itself.

These three parameters interact to turn your QS into a powerful MIDI controller. We've already mentioned that it can transmit on 16 MIDI channels simultaneously from different zones of the keyboard (which can overlap, if you want). But there's more. A lot more.

For example: You can send volume, panning, and transposition information to an external MIDI sound source if you set both MIDI Input and Keyboard to OFF for that channel.

If this sounds like something you would like to learn more about, why not spend some time going through *Part 5: MIDI?* We've got the information laid out for you there.

## **CONTROLLERS**

The Controllers function (press [100]) lets you turn on and off the various MIDI controllers that can affect the selected MIDI channel. The following four parameters determine whether or not specific types of MIDI information will be received or transmitted, and are set separately for each Channel in the Mix. These, however, are dependent on how each Channel has its KEYBOARD/MIDI parameters set (see the previous section).

### **Pitch-bend and Modulation Wheels (On or Off) Page 1**

This determines whether or not the selected channel will transmit and receive pitch-bend and modulation (controller 1) MIDI information.

### **Aftertouch (On or Off) Page 2**

This determines whether or not the selected channel will transmit and receive aftertouch MIDI information.

### **Sustain Pedal (On or Off) Page 3**

This determines whether or not the selected channel will transmit and receive sustain pedal (controller 64) MIDI information.

### **Controllers (On or Off) Page 4**

This determines whether or not the selected channel will allow Controllers A–D and Pedals 1 & 2 to transmit and receive MIDI controller information (reception only for Pedal 2, since there's no Pedal 2 input on the QS). You can assign which MIDI controller numbers they are linked to in Global Edit Mode, Pages 8 through 13. See *Part 4 BASIC OPERATION* for more information.

## SETTING THE RANGE

The Range function (press [110]) allows you to specify the number of keys to which each MIDI channel will respond. This is ideal for creating splits (e.g., bass on the lower keys, piano in the middle, and strings in the upper octave).

### Lower Limit (MIDI note 000 to 127/ C-2 to G8)

Page 1

Specifies the lowest note of the Program's range. You can set the lower limit when you're on this page by holding the [110] button and tapping one of the keys.

### High Limit (MIDI note 000 to 127/ C-2 to G8)

Page 2

Specifies the highest note of the Program's range. You can set the high limit when you're on this page by holding the [110] button and tapping one of the keys.

## QS8.1 Keyboard Range

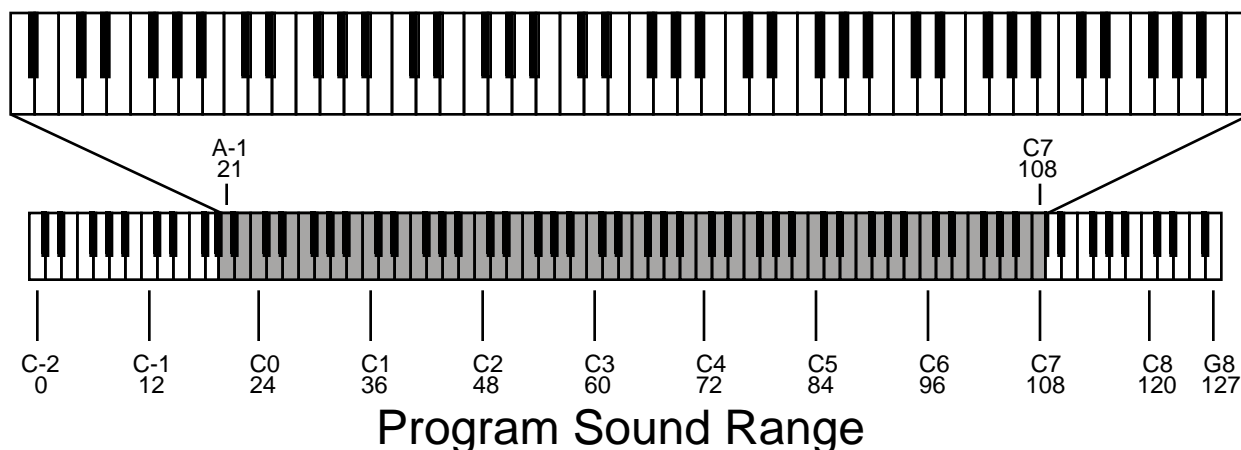

## NAMING A MIX

The Name function (press [120]) allows you to change the name of the Mix, which can be up to 10 characters long. Use the [◀ PAGE] and [PAGE ▶] buttons to position the cursor, and then use the [CONTROLLER D] slider and the [VALUE] buttons to select from the available characters:

	!	"	#	\$	%	&	'	(	)	*	+	,	-	.	/	0	1	2	3
4	5	6	7	8	9	:	;	<	=	>	?	@	A	B	C	D	E	F	G
H	I	J	K	L	M	N	O	P	Q	R	S	T	U	V	W	X	Y	Z	[
¥	]	^	_	`	a	b	c	d	e	f	g	h	i	j	k	l	m	n	o
p	q	r	s	t	u	v	w	x	y	z	{		}						

## PART 8

# EDITING PROGRAMS

### OVERVIEW

Synthesizer programming is the art and science of shaping sounds in a particular way by altering the parameters of various components of the sound. Like music itself, learning synth programming is an ongoing process. Although this manual presents information about synthesizer programming, no manual can offer a complete course in programming (at least for a price customers would be willing to pay!).

If you're new to synthesizer programming, the best way to learn is to adjust different parameters as you play to discover how different parameter values affect the sound. Also, become familiar with the signal and modulation flow within the QS7.1/QS8.1 (as shown in the various block diagrams included in this manual) so that you can understand the many ways in which you can process a signal as it works its way from oscillator to output.

### THE "NORMALIZED" SYNTH VOICE

The first synthesizers were comprised of various hardware modules, some of which generated signals, and some of which processed those signals. These were designed to be general-purpose devices since nobody was quite sure how they would be applied; some engineers used them as signal processors, while keyboard players treated them as musical instruments. *Patch cords* connected the inputs and outputs of the various signal generating and processing modules (which is why particular synth sounds were called *patches*). Changing a patch involved manually repositioning patch cords and adjusting knobs and switches; recreating a patch required writing down all the patch settings on paper so they could be duplicated later. Even then, due to the imprecision of analog electronics, the patch might not sound exactly the same.

Over the years, certain combinations of modules seemed to work better than others, and since patch cords were troublesome to deal with, eventually these modules were wired together in a "normalized" configuration. ("Normalized" in this sense means internally patched, and that the signal generally flows through the modules in a pre-determined direction.) Synthesizers such as the MiniMoog™, Prophet-5™, and others eliminated the need for patch cords by containing a normalized collection of sound modules (including oscillators, filter, envelopes, LFOs, etc.).

The QS offers the best of both worlds. The most commonly-used, normalized configurations are built-in to every program for ease of programming. In addition, the QS Modulation Matrix gives back much of the flexibility of a modular synthesizer, allowing you to map various modulation sources to multiple destinations for special needs. If you're a beginner, all of the normalized pathways are easy to find; as you gain experience you can explore more advanced features.

## HOW THE QS GENERATES SOUND

The QS uses custom integrated circuits, developed by the Alesis engineering team specifically for the QS. These resemble the types of chips used in computers and other digital devices. In fact, you can think of the QS as a special-purpose computer designed to generate and process audio. Although the user interface maintains the metaphor of “modules,” in fact all sounds are simply a set of numbers reflecting how you’ve programmed the various sound parameters. For example, when you change the filter cutoff frequency, you’re not actually messing with a filter; you’re telling the computer to simulate the effect of messing with a filter.

Each “module” is represented by parameters that appear on one or more display pages. The [▲ VALUE]/[ VALUE ▼] buttons and the [CONTROLLER D] slider let you change these parameters. All “patching” is done via software, so the only patch cords you need are those that go to your mixer or amplifier.

You can take a “snapshot” of the QS’s parameters and save this in memory as a *program*. The QS comes with 512 factory preset programs, and 128 user-editable programs.

## PROGRAM SOUND LAYERS

The simplest method of programming is to take one voice, process it through the filter and amp sections, and (if desired) add some effect to it. However, more elaborate Programs usually consist of 2 to 4 layers, with each layer making its own distinct contribution to the sound, for example:

- An organ program with Program Sound 1 set to a sustained organ waveform, and Program Sound 2 set to a percussion waveform with a fast decay.
- A piano program with one layer tuned normally, and a second layer tuned an octave higher.
- A synthesizer program with one layer set to a sharp attack waveform, a second layer set to an acoustic waveform, and a third layer with a slow-attack string waveform.

This may remind you of Mix Play Mode, where playing the keyboard can sound up to 16 different Programs at once. There are many similarities. In Mix Play Mode, you can make the same kind of layered Mix as you can with the four Sounds of a Program. But there are differences:

### Use Program Layers:

- If you want multiple sounds to respond to a single MIDI channel. For example, if you need to play a three-way layered synthesizer sound that was assembled in Mix Play Mode instead of Program Play Mode, you must send 3 Note On messages from your sequencer (one for each channel) for every note; a layered program would need only one Note On message.
- When layers of a Program are designed to be used together, and the individual layers by themselves wouldn't be used alone (for example, the percussion layer of the organ sound).



Use Mix Play Mode:

- When you want to layer more than four voices. In Mix Play Mode, it is possible (though not advisable) to stack all 64 voices onto a single key.
- When each sound is likely to be used by itself by other setups. For example, if you are programming three different keyboard splits, each of which uses the same left-hand bass patch, it makes sense to use Mix Play Mode.
- When you want different sounds to respond to different MIDI channels.

## QS SIGNAL FLOW

### THE FOUR SOUNDS OF A PROGRAM

Each Program is made up of at least one to four Sounds. A Sound is made up of several components including a voice (the original sound material) which passes through a low-pass filter and an amplifier. The voice, filter and amp modules each have direct modifiers (Low Frequency Oscillators [LFOs] and Envelopes) which affect how each will function in the Program. You can layer these Sounds together, or divide them into regions of the keyboard, or a combination of these things.

The following diagram illustrates the signal flow within each QS Program.

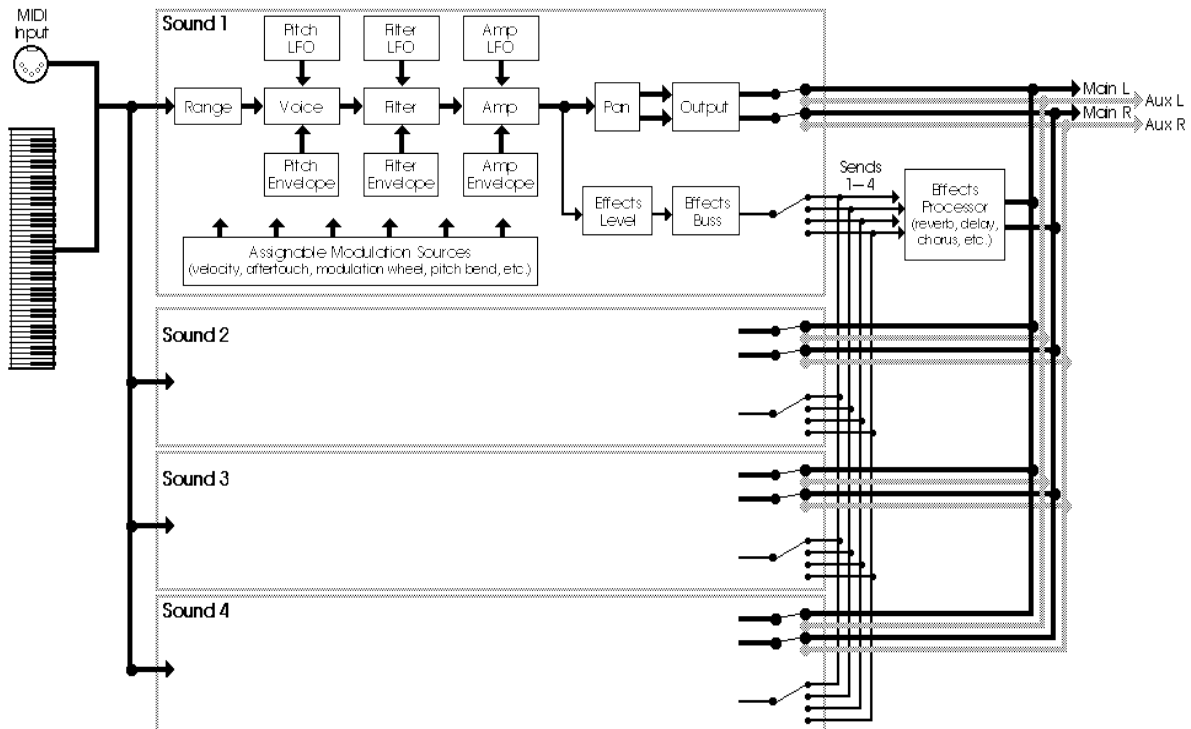

When editing a Program, use the [00] - [30] buttons to select the Sound layer you want to edit.

Let's look at each module's function in detail.

## THE VOICE

This digitally-based oscillator provides the actual raw sounds from the 16 megabyte library of on-board samples. These "raw sounds" can take the form of a simple synth wave, a multi-sample of a grand piano, an orchestra, or even a full drumkit! The oscillator's pitch can be tuned to a fixed frequency or *modulated*. Modulation is the process of varying a parameter dynamically over time; the oscillator pitch can be modulated by an envelope, velocity, pressure, pedal, LFO, and other control sources (described later). In this manual we frequently refer to the "Sound", which is a combination of the Voice, the Filter, the Amplitude section, and the various ways of modulating them.

In their raw forms (such as you would hear after re-initializing the QS) the samples on the QS have a constant sustaining amplitude, like an organ. In order to shape the sound so it fades, you would use an envelope or two (keep reading!).

## LOWPASS FILTER

A lowpass filter varies a signal's harmonic content by progressively increasing attenuation above a specified *cutoff frequency*. The higher frequencies are filtered, while the lower frequencies are allowed to "pass-thru." When the cutoff frequency is set high, the sound becomes brighter; when set low, the sound becomes bassier since fewer harmonics are present.

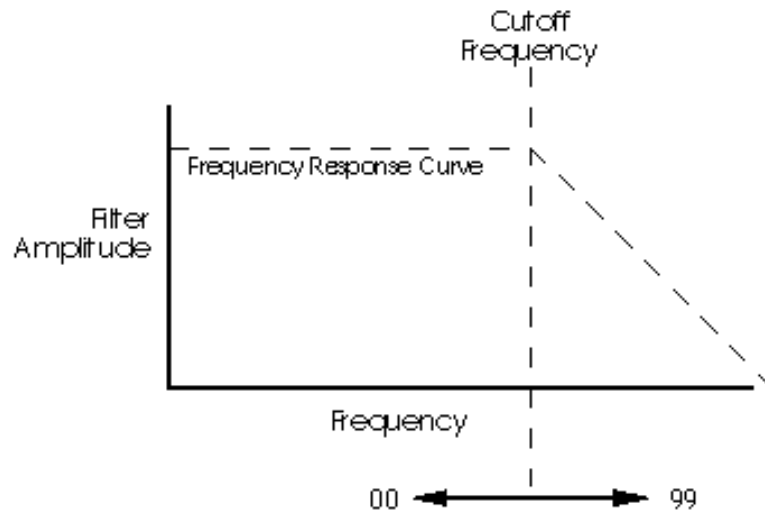

The cutoff parameter changes the frequency at which the high-frequency response starts to roll off. Lower values give a lower cutoff frequency. A value of 00 will cut all sound off.

Static (non-changing) filter settings can be useful, but varying the filter cutoff dynamically over time often produces more interesting effects. Modulating with velocity can produce brighter sounds when you play harder, which produces a more accurate acoustic instrument simulation. Modulating with an envelope can create a pre-defined change in harmonic structure, such as having a brighter attack and bassier sustain portion (the point at which the envelope rests before you release the key).

## AMP

Each voice/filter combination is followed by an amplifier whose level can be controlled by a variety of modulation sources. This allows for creating sounds with percussive or slow attacks, particular types of decays, tremolo, etc.

Filter and amp settings can interact. If the filter cutoff is extremely low, then no signal will get through, no matter how the amp is set. Similarly, setting the amp for a short decay won't let you hear any filtering set for a longer decay. This is because the volume will reach zero before the filter decay finishes.

## ABOUT MODULATION

In this manual, the word "modulation" means "to modify some aspect of a sound over time". Since oscillators make static sounds (unlike acoustic instruments, whose timbre and dynamics change—often radically—over the duration of a note), modulation is the key to making rich and expressive sounds. The vibrato of a flute, the expression pedal of an organ, a wah-wah pedal on a guitar—all of these are examples of modulation. You're probably familiar with the mod wheel of a synthesizer, which typically adds vibrato to a Program as it is raised. But in synthesizer programming, modulation is used to control even the basic characteristics of a voice: its attack, decay, and release times, for example. Every box in the signal diagram on page 109 pointing towards the Voice, Filter, or Amp boxes is a *modulation source*. The amount of modulation, the time it takes place, and what controls (such as key velocity, footpedals, aftertouch, mod wheel etc.) affect it are important parameters in every Program. The QS provides the modulation flexibility of patch cord-based instruments, but with the convenience and ease of use of digital technology.

With some parameters, the modulation amount can be positive or negative. A positive control signal increases the value of the parameter being controlled. A negative control signal *decreases* the value of the parameter being controlled. Setting modulation to 00 turns off the modulation source. *Example:* Keyboard velocity can either make a Sound brighter the harder you play (*positive* modulation), make it less bright (*negative* modulation), or have no effect on the Filter at all. You have the freedom to set modulation any way you want, even in ways that are the opposite of what they would be on an acoustic instrument.

If a "baseline" setting exists for a parameter, modulation amounts add or subtract values from the existing setting. However, modulation cannot force a value beyond its maximum range. For example, if the Amp is already at its minimum value (lowest level), you could apply positive modulation to raise the level. But applying negative modulation will not affect the Amp level, since it's already at its lowest value and cannot go any lower.

The QS lets you assign several modulation sources to one modulation "target" parameter, which allows for interaction between two modulation signals. *Example:* If the Amp parameter responds to both the envelope generator and a pedal, the amplitude will follow the general envelope shape but will also be influenced by the pedal.

## LFO (LOW FREQUENCY OSCILLATOR)

The pitch, filter, and amp modules each have a dedicated LFO module for modulation. The term LFO stands for low frequency oscillator, and comes from how modulation was created in the early synth days (an oscillator set to a low frequency could modulate some aspect of the sound; routing the LFO to the pitch, for example, would create vibrato). The LFO creates a cyclic (periodic) modulation; this amount can be constant and/or varied with a variety of modulation sources (mod wheel is one of the most popular). Each LFO has a waveform shape and speed, along with other controls.

## ENVELOPES

Envelope generators provide a modulation signal that varies over time, from the time you strike the key until after you let go. There are three independent envelope generators (for pitch, filter, and amp) in each Program Sound. An envelope generator has different effects on different modules. *Example:* The Amp Envelope creates level changes. Amplitude that decays over time creates percussive effects (plucked strings, drums, etc.). Amplitude that increases over time gives the effect of brass, woodwind, and some bowed instruments.

Each envelope generator has the standard attack, decay, sustain, and release parameters found on most synthesizers, along with delay, sustain decay, and different triggering options.

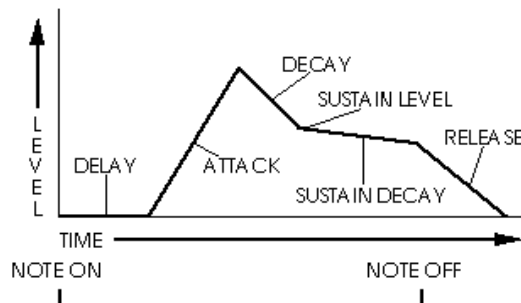

## ABOUT SIGNAL PROCESSING

The QS features a signal processing section based on the Alesis QuadraVerb 2. It is a complete digital signal processing unit with four input buses, simultaneous multiple effects, and flexible signal routing.

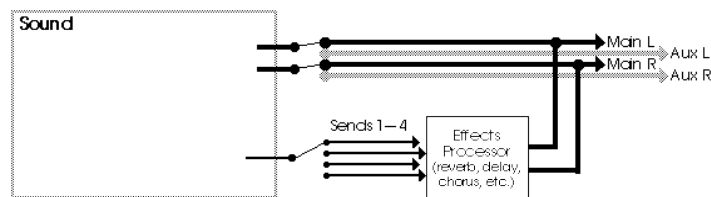

Effects parameters are edited separately from either the Program or the Mix, using Effects Edit Mode (but must be stored within a Program. More in *Part 6: Editing Effects*). In Program Edit Mode, each of the four Sounds in the Program has its own Effect Level control and can be assigned to any one of the four effect buses. Effects

settings, Effect Level and Bus information are saved with the Program when you store it back into memory.

## DRUM MODE

Drum Mode helps you personalize your music by allowing you to construct your own drumkits. Any one or all of the four Sounds in a Program can be put into Drum Mode. The parameter which controls this is found in the Voice Function (button [40]) on page 2. But before we get into that, please note that Drum Mode isn't the only way to hear drums or percussion from a Program. In Keyboard mode (which we'll explain shortly), if you select a kit (such as "Rock Kit 1") as the voice of a Program Sound, an entire arrangement of preset, pre-mapped drum sounds will be assigned across the keyboard. If you select a single drum (such as "Timpani") as the voice, that single drum sound will sound across the keyboard range, with a different pitch on each note (the original sample pitch will appear on C3). In either case, in Keyboard mode you treat the entire Sound as a single instrument, with only one pan position, level, or Effects Send amount or Bus.

However, Drum Mode changes the nature of the VOICE function, giving you the ability to select 10 drum samples per Sound and individually control their pitch, level, panning, effects routings, and placement on the keyboard. Drum Mode allows you to construct your own drum kit from a collection of 343 samples: 21 kicks, 26 snares, 33 toms, 43 cymbals, 75 percussion instruments, 82 sound effects and 63 synth waves. Plus, there are 90 rhythm beats to choose from (pre-sequenced drum loops). When a Sound is in Drum Mode, you can assign 10 different drum samples to 10 different keys anywhere on the keyboard. If all four Sounds in a Program were placed in Drum Mode, you could assemble up to 40 tailor-made drum sounds in your kit. To round things out, individual drums can be "stretched" to occupy up to four consecutive keys without transposing (for more realistic flams).

Here is a block diagram of a Sound in Drum Mode.

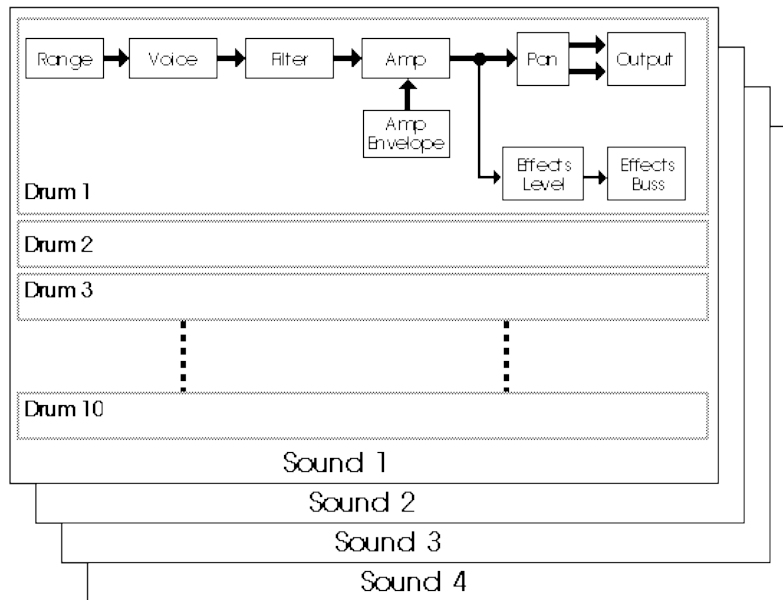

When Drum Mode is enabled, the Sound will have fewer parameters for editing. Consequently, not all Function buttons will respond when pressed as they do when the Sound is in Keyboard mode. Specifically, the LFOs and all Envelopes (with the

exception of the Amp Envelope) are unavailable. In addition, the parameters in most other functions will differ. For more information on Drum Mode, see page 151.

## **STORING YOUR EDITED PROGRAMS**

As you go through the parameters on the following pages, don't forget that if you come up with an edit you would like to keep, you need to store it before you go to another Program or else you will lose your edit!

Storage of Programs and Mixes was covered thoroughly in *Part 4: Basic Operations*. But if you'd like to know a great tip on what to do if you've created a great edit but aren't sure where you'd like to store it, check the end of this chapter. There's a section there called "Special Programming Functions" with a subsection called "To Audition Programs Before Storing", which gives you a great workaround for this dilemma.

## PROGRAM EDIT FUNCTIONS

To edit a Program you must select Program Edit mode. This is done by pressing the [EDIT SELECT] once from Program Play Mode (each time you press [EDIT SELECT] in Program Mode, the display cycles between Program Edit and Effects Edit Modes). When editing a Program in Program Mode, the word "EDIT" will appear in the display's mode section (lower-left corner):

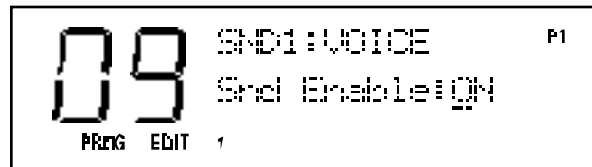

As soon as you change a value, the word "EDIT" will change to "EDITED".

A Program may also be edited from within a Mix. This requires that you press the [EDIT SELECT] button twice from Mix Play Mode (each time you press [EDIT SELECT] in Mix Mode, the display cycles between Mix Edit, Program Edit and Effects Edit Modes). When editing a Program in Mix Mode, the words "MIXPROG EDIT" will appear in the display's mode section (lower-left corner), and the channel number that is being edited will flash:

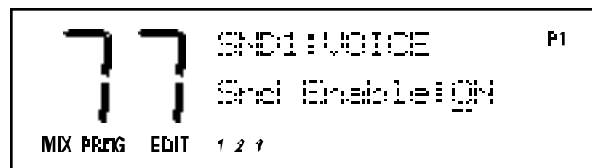

And again, as soon as you change a value, the word "EDIT" will change to "EDITED".

**TIP:** *Now that we're about to cover the various parameters in Program Edit mode, don't forget the "Double-button push" trick! This is where you push both of the [VALUE] buttons or both of the [PAGE] buttons at the same time as a shortcut. You'll find it detailed in Part 4: Basic Operation on page 35.*



## VOICE

The Voice function (press [40]) is the most fundamental part of Program editing. It is where you choose the particular sample that forms the basis of a Sound. To avoid scrolling through long lists of samples (remember, there are 16 megabytes of sounds in here!), sounds are divided into groups. After selecting the group, you then select the sound within the group.

### Sound Enable

Page 1

This is the master on/off switch for the selected Sound (1–4) of the current Program.

To avoid using up polyphony unnecessarily, set Sound Enable to OFF for any Sounds that will not be used in a Program. Turning Sounds off is also a convenient way to isolate a particular sound you are editing. When the Sound being edited is disabled, the upper line of the display will show the letters “snd” in lowercase letters. When the Sound being edited is enabled, the letters “SND” will appear in uppercase letters. The same thing happens when editing a Program from Mix Mode.

## TIP:

***Muting and Unmuting Sounds.** A quick way to turn a Sound on and off from anywhere within Program Edit Mode is to hold the corresponding Sound button [00]–[30] and press [VALUE ▼] to disable or [▲ VALUE] to enable. Example: Holding [00] and pressing [VALUE ▼] will disable Sound 1.*

### Sound Type

Page 2

This determines whether a Sound layer is going to be in Keyboard Mode or Drum Mode. Drum Mode allows you to assign individual drum sounds to individual keys. To Program a Sound in Drum Mode, refer to the section “Programming Drum Sounds” on page 151.

### Sound Group (17 options)

Page 3

Choose from among 17 different sample groups (see chart on the next page).

**Sound**

Selects one of the available samples by name from the selected group, or OFF (no sample selected). Each group has a variety of samples from which you can choose, although some groups (such as waves) have more samples than others.

Below and on the following page, you'll find a chart listing the various samples in their respective groups.

Group	Voice
Piano	GrndPianoL, GrndPianoR, DarkPno1 L, DarkPno1 R, DarkPno2 L, DarkPno2 R, DarkPno3 L, DarkPno3 R, BritePno1L, BritePno1R, BritePno2L, BritePno2R, BritePno3L, BritePno3R, 4::VibesWave, NoHammer R, SoftPianoL, SoftPianoR, VeloPianoL, VeloPianoR, TapPiano L, TapPiano R, E Spinnet 1, E Spinnet 2, Toy Pno L, Toy Pno R, KeyTrack1, KeyTrack2, Stretch L, Stretch R, PianoWaveL, PianoWaveR, BriteRoads, Dark Roads, Soft Roads, VeloRoads1, VeloRoads2, VeloRoads3, Wurly, VeloWurly1, VeloWurly2, FM Piano, FM Tines, Soft Tines, VelAtkTine, Vel FM Pno, BrtRdsWave, DrkRdsWave, SftRdsWave, Wurly Wave
Chromatic	Clavinet, VelAtkClav, ClavntWave, Harpsicord, VAtkHarpsi, HarpsiWave, Glock, Xylophone, Marimba Hd, Marimba Sf, MarimbaVel, Vibraphone, VibesWave, Ice Block, Brake Drum, TubulrWave, TubWv/Null, FMTblrBell, FMTublrSft, FMTublrVel, FMTub/Null
Organ	Rock Organ, Perc Organ, FullDrwbr1, FullDrwbr2, 3 Drawbars, 4 Drawbars, UpprDrwbrs, 16'Drawbar, 5 1/3' bar, 8' Drawbar, 4' Drawbar, 2 2/3' bar, 2' Drawbar, 1 3/5' bar, 1 1/3' bar, 1' Drawbar, Percus 2nd, Percus 3rd, Percus Wav, HollowWave, 60's Combo, RotarySpkr, ChurchOrgn, Principale, Positive
Guitar	SteelStrng, NylonGuitr, Nylon/Harm, Nylon/Harp, JazzGuitar, SingleCoil, Sngle/Mute, DoubleCoil, DCoil/Harm, DCoil/Jazz, D/S Coil, MicroGuitr, PwrH/MGtr1, PwrH/MGtr2, MuteGuitar, Mute Velo, Metal Mute, MGtr/MtlMt, MtlMut/Hrm, Fuzz Wave, ClsHarmncs, ElecHarmnc, Pwr Harm 1, Pwr Harm 2, Pwr Harm 3, PwrHrmVel1, PwrHrmVel2, PwrHrmVel3
Bass	StudioBass, Studio&Hrm, Studio/Hrm, Slp/Studio, Slap Bass, Slap&Harm, Slap/Harm, Slap/Pop, Pop/Slap, Bass Pop, Pop/Harm, Harm/Pop, JazzFingrd, Fingr&Harm, JazzPicked, Pickd&Harm, Jazz Velo, Muted Bass, Stik Bass, Stik&Harm, Stik/Harm, Harm/Stik, Fretless, Frtls&Harm, AcousBass1, AcoBs1&Hrm, AcousBass2, AcoBs2&Hrm, VelAcoBass, 3-VelBass1, 3-VelBass2, 3-VelBass3, 3-VelBass4, BassHarmnc
String	StringEnsm, TapeStrngs, SoloString, SoloViolin, Solo Viola, Solo Cello, Contrabass, Pizz Sectn, Pizz Split, Pizz/Strng, Strng/Pizz, StringAttk, Harp, Hi Bow, Low Bow
Brass	Pop Brass, ClasclBras, AttakBrass, Trumpet, HarmonMute, Trombone, FrenchHorn, Bari Horn, Tuba
Wdwind	Bassoon, Oboe, EnglishHrn, Clarinet, Bari Sax, BrthyTenor, Alto Sax, SopranoSax, Velo Sax, Flute, Flute Wave, Shakuhachi, PanPipe Hd, PanPipe Md, PanPipe Sf, PanPipeVel, Pan Wave, BottleBlow, BottleWave
Synth	J Pad, M Pad, X Pad, Velo Pad 1, Velo Pad 2, Velo Pad 3, AcidSweep1, AcidSweep2, AcidSweep3, AcidSweep4, AcidSweep5, VeloAcid 1, VeloAcid 2, VeloAcid 3, VeloAcid 4, Chirp Rez1, Chirp Rez2, Chirp RezV, Quack Rez1, Quack Rez2, Quack Rez3, Quack Rez4, QuackRezV1, QuackRezV2, QuackRezV3, Uni Rez 1, Uni Rez 2, Uni Rez 3, Uni Rez V, AnalogSqr1, AnalogSqr2, AnalogSqrV, SyncLead 1, SyncLead 2, SyncLead V, Seq Bass, Seq BassV1, Seq BassV2, FatSynBass, TranceBas1, TranceBas2, VeloTrance, FunkSynBs1, FunkSynBs2, FunkSynBs3, FunkSynBsV, FilterBass, FM Bass, FM/FiltVel, Soft Chirp, Soft Rez
Wave	Pure Sine, 10% Pulse, 20% Pulse, 50% Pulse, Velo Pulse, Mini Saw, Saw Fltr 1, Saw Fltr 2, Saw Fltr 3, Saw Fltr 4, Saw Fltr 5, Saw Fltr 6, Saw Fltr 7, RezSaw UK, RezSaw USA, Acid Saw, Velo Saw 1, Velo Saw 2, Velo Saw 3, Velo Saw 4, Velo Saw 5, Velo Saw 6, AcidRezSqr, VelAcidWav, MiniSquare, Sqr Fltr 1, Sqr Fltr 2, VeloSquare, Mini Tri, Tri Filter, Velo Tri, Rectanglar, Hard Sync, HSync/Rect, BrightSync, Rez Sync, Ring Mod, RingMod V1, RingMod V2, OctaveLock, Diet Saw, Band Saw, Notch Saw, HiPassSaw1, HiPassSaw2, HiPassSaw3, HiPassSaw4, HiPassVel1, HiPassVel2, HiPassVel3, HiPassVel4, HiPassVel5, HiPassVel6, Cognitive, Additive 1, Additive 2, VeloAdditiv, Digital 1, Digital 2, Digital 3, Digital 4, Science 1, Science 2, Science 3, Science 4, VelScience, Metal Wave, Inharmonic1, Inharmonic2
Noise	WhiteNoise, Spectral, Crickets, Rain Noise, FiltrNoise, ShapeNoise, VeloNoise1, VeloNoise2, VeloNoise3, NoiseLoop1, NoiseLoop2, NoiseLoop3, NoiseLoop4, NoiseLoop5
Voice	VocalAhhs, Soft Ahhs, Ahhs Wave, VocalOohs, Soft Oohs, Oohs/Ahhs, Ahhs/Oohs, Whistle, Phonic

Ethnic	Sitar, Sitar Wave, Shamisen, Koto, DulcimerHd, DulcimerMd, DulcimerSf, DulcimerVel, DulcimerWave, MandlnTrem, Accordian, Harmonica, Banjo, Kalimba, Steel Drum, Tuned Pipe
Drums	Stndrd Kit, Rock Kit 1, Rock Kit 2, Dance Kit, Brush Kit, ElctricKit, Tek Kit, Rap Kit, Street Kit, MetalliKit, HvyMtlKit, VeloMtlKit, Trip Kit 1, Trip Kit 2, Trip Kit 3, Wild Kit, Octave Kit, OrchestraKt, Raga Kit, FloppyKick, PillowKick, MasterKick, Metal Kick, Smoke Kick, GrooveKik1, GrooveKik2, Sharp Kick, Tek Kick, AnalogKick, Rap Kick, FatWoodSnr, HR Snare, Master Snr, PiccoloSnr, Electrn1, Electrn2, Rap Snare1, Rap Snare2, Tek Snare, Brush Snr, Crosstick, Hi Tom, Mid Tom, Low Tom, Cannon Tom, Hex Tom, Rap Tom, Closed Hat, HalfOpnHat, Open Hat, Foot Hat, TekHatClsd, TekHatOpen, RapHatClsd, RapHatOpen, CricketCHH, CricketTIK, CricketsOHH, FltrNoisCH, FltrNoisOH, Ride Cym, Ride Bell, Crash Cym, Null/ Crash, Splash Cym, China Cym, Rap Cymbal, RapCymWave, StndrdKtDM, RockKit1DM, RockKit2DM, DanceKitDM, BrushKitDM, ElctrcKitDM, Tek Kit DM, Rap Kit DM, StreetKtDM, TripKit1DM, TripKit2DM, TripKit3DM, OctavKitDM, OrchestraDM
Percus	Agogo, Bongo, Cabasa, Castanet, Chimes 1, Chimes 2, Chimes 3, Clap Rap, Clap Tek, Clave 1, Clave 2, Conga Hit1, Conga Hit2, CongaSlap1, CongaSlap2, Rap Conga, Rap Rim, Cowbell, RapCowbell, Cuica, Djembe Hi, Djembe Low, Drumstix, FingerSnap, GuiroLong1, GuiroLong2, GuiroShort, Maracas, SmbaWhstl1, SmbaWhstl2, ShortWhstl, Shaker Hi, Shaker Low, Sleighbel1, Sleighbel2, Tabla Ga, Tabla Ka, Tabla Ka 2, Tabla Na, Tabla Te, Tabla Te 2, Tabla Tin, Taiko Drum, Taiko Rim, Talk Down, Talk Up, Tambourine, Timbale, Timpani, Null/Timp, Triangle 1, Triangle 2, TrianglSf1, TrianglSf2, Udu Hi, Udu Mid, Udu Low, Udu Slap, Vibrasmak1, Vibrasmak2, Wood Block
SndFX	Rain 1, Rain 2, Bird Tweet, Bird Loop, Telephone, Jungle 1, Jungle 2, Jungle 3, Jungle 4, GoatsNails, ScrtchPul1, ScrtchPul2, ScrtchPsh1, ScrtchPsh2, ScratchLp1, ScratchLp2, ScrtchPLp1, ScrtchPLp2, ScrtchPLp3, ScrtchPLp4, Orch Hit, Null/Orch, Dance Hit, Null/Dance, Rez Zip, RezAttack1, RezAttack2, RezAttkVel, Zap Attk 1, Zap Attk 2, Zap Attk 3, Fret Noise, Sci Loop 1, Sci Loop 2, Sci Loop 3, Bit Field1, Bit Field2, Bit Field3, Bit Field4, Bit Field5, Bit Field6, WavLoop1.0, WavLoop1.1, WavLoop1.2, WavLoop1.3, WavLoop1.4, WavLoop1.5, WavLoop1.6, WavLoop1.7, WavLoop1.8, WavLoop2.0, WavLoop2.1, WavLoop2.2, WavLoop2.3, WavLoop2.4, WavLoop2.5, WavLoop2.6, WavLoop2.7, WavLoop2.8, WavLoop3.0, WavLoop3.1, WavLoop3.2, WavLoop3.3, WavLoop3.4, WavLoop3.5, WavLoop4.0, WavLoop4.1, WavLoop4.2, WavLoop4.3, WavLoop4.4, WavLoop4.5, D-Scrape, D-ScrapeLp
Rhythm	Psi Beat 1, Psi Beat 2, Psi Beat 3, Psi Beat 4, Psi Beat 5, Psi Beat 6, Psi Beat 7, Psi Beat 8, Psi Beat 9, Psi Beat10, Psi Beat11, Psi Beat12, Kick Loop1, Kick Loop2, Kick Loop3, Kick Loop4, Kick Loop5, Kick Loop6, Kick Loop7, Kick Loop8, Kick Loop9, KickLoop10, KickLoop11, Snare Lp 1, Snare Lp 2, Snare Lp 3, Snare Lp 4, Snare Lp 5, Snare Lp 6, Snare Lp 7, Snare Lp 8, Snare Lp 9, SnareBeat1, SnareBeat2, SnareBeat3, SnareBeat4, SnareBeat5, Back Beat1, Back Beat2, Back Beat3, Back Beat4, Hat1 Clsd1, Hat1 Clsd2, Hat1 Foot, Hat1 Open1, Hat1 Open2, Hat2 Clsd1, Hat2 Clsd2, Hat2 Foot, Hat2 Open1, Hat2 Open2, Hat3 Clsd1, Hat3 Clsd2, Hat3 Open1, Hat3 Open2, Hat Beat 1, Hat Beat 2, Hat Beat 3, Hat Beat 4, Hat Beat 5, Hat Beat 6, Hat Beat 7, Hat Beat 8, Hat Beat 9, Hat Beat10, Agogo Loop, Bongo Loop, CabasaLoop, CastanetLp, CongaLoop1, Shaker Lp1, Shaker Lp2, SleighLoop, Tabla Ga Lp, Tabla Ka Lp, Tabla Na Lp, Tabla Te Lp, TablaTin Lp, Taiko Loop, PercBeat1, PercBeat2, PercBeat3, PercBeat4, VoiceLoop1, VoiceLoop2, PhonicLoop, SpinalLoop, Tr Loop 1, Tri Loop 2, Orch Loop

## LEVEL

The Level function (press [50]) allows you to control the volume, pan position, output assignment and effects send level for each Sound. With up to four Sounds per program, this allows for a wide variety of stereo effects and level balances between the sounds.

### Volume (00 to 99) Page 1

This sets the overall volume for a Sound. Higher numbers give higher levels.

### Pan (<3 to 3>) Page 2

There are 7 available pan locations in the stereo (two-channel) field: Far left (-3), mid left, near left, center (< >), near right, mid right, and far right (+3).

### Output (Main, Aux, or Off) Page 3

The Output parameter has three settings. To send the Sound's output to the Main outputs, select MAIN. To route the dry signal of the Sound to the Aux Outputs, select AUX. To turn off the Sound's direct output altogether, set this parameter to OFF. (Note, however, that in the last two cases the Sound may still feed an Effect Send, which can be very useful. Try it!).

**TIP:** To achieve four independent Outputs requires a combination of the Pan and Output parameters. For example, if you want to isolate Sounds 1-4 and send each to its own Output, here are some settings you could use:

	Output setting	Pan setting	FX Level
Sound 1	MAIN	< 3 (hard left)	00 (dry)
Sound 2	MAIN	3 > (hard right)	00 (dry)
Sound 3	AUX	< 3 (hard left)	00 (dry)
Sound 4	AUX	3 > (hard right)	00 (dry)

### Effect Level (00 to 99) Page 4

The QS isn't just a synthesizer; it also has a built-in effects system and mixer, with four effect buses and sends. This section lets you feed the Sound to one of the effect buses for processing (see Part 6 for more information on editing Effects). The Effect Level parameter determines how much of the Sound feeds the chosen effect bus (see below). Higher values mean that the sound will be more "effected".

### Effect Bus (1 to 4) Page 5

Selects which of the four buses the Sound will feed, thereby determining which effect(s) will process the Sound. Each Program has its own unique arrangement of effects. *Example:* In Program #12, bus 1 may be a Chorus/Delay/Reverb, while in Program #27, bus 1 may just be a Flanger.

## PITCH

The Pitch function (press [60]) lets you control the pitch aspects of each Sound layer.

### **Semitone (-24 to +24 semitones) Page 1**

Sets the oscillator pitch in semitone steps, from -24 (transposed down two octaves) to +24 (transposed up two octaves).

### **Detune (-99 to +99 cents) Page 2**

Sets the oscillator pitch in cents, from -99 (transposed down 99/100 of a semitone) to +99 (transposed up 99/100 of a semitone).

### **Detune Type (Normal or Equal) Page 3**

With Normal selected, the *percentage* of detuning remains the same over the entire range of the keyboard, so the effects of detuning sound the same no matter which key you play. With Equal selected, the *absolute amount* of detuning remains the same over the entire keyboard, so any detuning seems less pronounced as you play higher up on the keyboard.

### **Pitch Wheel Range (0 to 12 semitones) Page 4**

Determines the maximum amount of pitch bend when the [PITCH] wheel is full forward. *Example:* When set to 12, the pitch wheel can bend  $\pm 1$  octave (12 semitones).

### **Aftertouch Depth (-99 to +99) Page 5**

At +00, aftertouch has no effect on pitch. Applying aftertouch (by pressing harder on the keyboard, or via MIDI messages) with this parameter set to a positive value raises the pitch; conversely, applying aftertouch through a negative value lowers the pitch. The higher the number (either positive or negative), the greater the amount of pitch change for a given amount of aftertouch.

### **Pitch LFO Depth (-99 to +99) Page 6**

At +00, the pitch LFO has no effect. Higher positive values increase the amount of Pitch LFO modulation. Negative values give the same apparent effect, but with reversed LFO phase (i.e., if the pitch would normally be increasing with depth set to a positive number, the pitch would instead be decreasing at that same moment had the depth been set to a negative number). Pitch LFO parameters (such as speed and wave shape) are programmed within the Pitch LFO Function (see page 144).

*Note: Whether or not you hear a change when you edit this parameter depends on how the Program was created and whether the LFO has received input from a modulator (such as the Mod wheel). If you hear no change, try moving the Mod wheel up.*

### **Pitch Envelope Depth (-99 to +99)**

**Page 7**

At +00, the Pitch Envelope has no effect. Positive values raise the pitch from the baseline according to the envelope shape, while negative values similarly lower the pitch (see illustration below). The higher the number (negative or positive), the greater the effect. Pitch Envelope parameters (such as attack and decay time) are programmed within the Pitch Envelope Function (see page 130).

### **Portamento (Exponential, Linear, 1 Speed)**

**Page 8**

Normally, when you play two keys in a row the sound jumps instantly from one pitch to another. Portamento provides a sweeping glide from one note to the next over a variable amount of time. A good example of this type of sound is a steel guitar, where a note slides from one pitch to another.

This parameter determines the sweep's "curve."

- With an **exponential** curve, the pitch change seems to happen more rapidly at first, then slows down as it approaches the ending pitch.
- A **linear** curve produces a constant pitch change throughout the glide.
- **1 Speed**: Normally, the greater the interval (the pitch difference between the two notes), the longer the glide. For example, a glide between two notes a whole step apart would take much less time than a glide between two notes an octave apart. The 1 Speed curve maintains a constant glide rate regardless of the pitch difference between notes.

### **Portamento Rate (0 to 99)**

**Page 9**

Sets the glide duration. Higher numbers give longer glide times. The Rate value is affected by the Portamento value (see above).

---

**Keyboard Mode (Mono, Poly, 1-Pitch or 1-PMono)****Page 10**

In **Mono** mode, you can play only one note at a time—just like vintage monophonic synthesizers or wind instruments. **Poly** mode allows you to play polyphonically. Note that portamento behavior is more predictable in mono mode.

**TIP.** With a feedback guitar patch that uses one Sound for the guitar and one Sound for the feedback, setting the feedback sound to Mono Keyboard Mode insures that your feedback “whistle” will be monophonic, which more accurately mimics what happens when you play lead guitar.

Use **1-PITCH** mode when you want a program Sound layer to play a single pitch polyphonically throughout the entire keyboard range. In 1-PITCH mode, the QS will play the sample used for note C3 for all notes in the range. 1-PITCH mode is often used for layering a noise or drum sound behind another sound that is pitched, for example, to fatten up a bass guitar sound with a hint of kick drum, or to have the same cymbal hit every time any note is played. Alternatively, **1-PMONO** mode is a monophonic version of 1-PITCH.

Sometimes when playing a monophonic instrument, you will not want the envelopes to retrigger when playing legato, as this would sound unrealistic. Imagine a flute-player beginning each note in a phrase with a sharp, breathy attack. In reality, the player would only attack the first note in the phrase this way. If the QS's Keyboard Mode is set to “Mono” and you're striving for this sort of realistic articulation, we recommend an envelope Trigger mode of “Normal”. This is because the three envelopes (Pitch Envelope, Filter Envelope and Amp Envelope) will retrigger with every note you play when their Trigger Modes are set to “Reset” or “Reset-Freerun”. For more information on the various Envelope Trigger modes, see pages 131 and 134.

## **FILTER**

The Filter function (press [70]) lets you control the tone of each Sound layer.

### **Filter Frequency (00 to 99)**

**Page 1**

This sets the filter's initial cutoff frequency. Lower values give a duller sound since this removes more harmonics; higher values let through more harmonics, which gives a brighter sound.

Note: This parameter interacts with several others. If you hear no change when you raise the Filter Frequency amount, try lowering the Filter Envelope Depth on the FILTER function's page 7 (push [◀ PAGE] once to find it).

**TIP.** Signals with complex harmonic structures are most affected by the filter. *Examples:* A sine wave has virtually no harmonics so you will not hear any significant changes as long as the filter cutoff is higher than the note pitch. If the filter cutoff is lower than the note pitch, you will either not hear the note, or it will be very soft. A harmonically-rich sample (such as brass or white noise) will be greatly affected by the filter.

If the Filter Frequency is set to maximum, in most cases all other variables in the Filter function will have no effect (unless you modulate them negatively). Most other filter functions raise the filter frequency, and it can't be greater than 99. So if you want to use filter effects, proper setting of this initial cutoff frequency is crucial. This is the "baseline" from which all other filter parameters will raise or lower (open or close) the filter.

If the Filter Frequency is set to 00, and no other parameters are set to raise it dynamically, no sound will pass through the filter at all--there will be silence. If the Amp settings are wide open and you can't hear anything, check the Filter Frequency setting.

Since the waveforms in ROM are recorded at the brightest possible setting, in many cases dynamic filtering is crucial to making a program sound natural.

### **Keyboard Track (On or Off)**

**Page 2**

When this parameter is set to OFF, the filter cutoff remains constant across the keyboard. Higher notes will be more affected than lower notes, since the filter cutoff is comparatively lower for higher notes than lower ones.

When this parameter is set to ON, the filter frequency will track the keyboard pitch so that as you play different keys the filter cutoff will shift automatically. For example, when you play a higher note the filter cutoff point will automatically be raised somewhat.



**Velocity (-99 to +99)****Page 3**

At +00, velocity has no effect on the filter cutoff. With positive values, playing harder increases the filter cutoff. More positive values drive the cutoff frequency higher for a given amount of velocity. More negative values drive the cutoff frequency lower for a given amount of velocity.

**TIP.** Many acoustic instruments, such as acoustic guitars, sound brighter when you play them more forcefully. Adding a little positive velocity control over the filter can simulate more realistic acoustic sounds.

**Modulation Wheel Depth (-99 to +99)****Page 4**

Determines how moving the modulation wheel affects the filter cutoff frequency. *Example:* With positive settings, moving the modulation wheel up raises the filter cutoff frequency and moving it down lowers the filter cutoff frequency. With negative settings, moving the modulation wheel up lowers the filter cutoff frequency and moving it down raises the filter cutoff frequency .

**Aftertouch Depth (-99 to +99)****Page 5**

At +00, aftertouch has no effect on the filter cutoff frequency. Applying aftertouch with this parameter set to a positive value raises the filter cutoff frequency; conversely, applying aftertouch with a negative value lowers the filter cutoff frequency. The higher the number (either positive or negative), the greater the effect for a given amount of aftertouch.

**TIP.** Many acoustic instruments sound brighter as you play them more forcefully; in particular, brass gets brighter as you blow harder. Using aftertouch to increase a sound's brightness can give more control and realism with acoustic instruments.

**Filter LFO Depth (-99 to +99)****Page 6**

At +00, the filter LFO has no effect. Higher positive values increase the amount of filter LFO modulation. Negative values give the same apparent effect, but with reversed LFO phase (i.e., if the filter cutoff frequency would normally be increasing with depth set to a positive number, the cutoff would instead be decreasing at that same moment had the depth been set to a negative number). Filter LFO parameters (such as speed and wave shape) are programmed from within the Filter LFO Function on button [7] (see page 146).

Note: If you hear no change when you alter this parameter, spend some time experimenting with the Filter LFO Functions on button [7].

Another note: If your Filter LFO is using the Square, Up Saw, Down Saw, or Random+ waveshapes, you may get a more pronounced effect if you use a negative setting for Filter LFO Depth. See page 144 for more information about the various LFO waveshapes.

**TIP.** Filter LFO is good for giving wah-wah effects at slower LFO speeds, and for adding "shimmering" with higher LFO speeds.

## **Filter Envelope Depth (-99 to +99)**

**Page 7**

The Filter Envelope is one of the most important sets of parameters in making a Program. Many Programs will use the Filter Envelope to determine the tonal character of the sound over time (attack, decay, sustain, and release). At +00, the filter envelope has no effect. Positive values raise the filter from the baseline cutoff frequency according to the envelope shape, and negative values similarly lower the cutoff frequency. The higher the number (negative or positive), the greater the effect. Filter Envelope parameters (such as attack and decay time) are programmed within the Filter Envelope Function (see page 133).

Note: This parameter interacts with several others. If you hear no change when you raise the Filter Envelope Depth, try lowering the Filter Frequency on the FILTER function's page 1 (push [PAGE ►] once to find it).

## AMP/RANGE

The Amp/Range function (press [80]) lets you control the velocity and keyboard range of each Sound layer.

### Velocity Curve (13 choices)

Page 1

This selects how the Sound will respond to an increase in velocity values from the keyboard or MIDI. A LINEAR curve is the norm, where the velocity values increase the level evenly as you play harder. Many of the Velocity Curves are parts of "sets" which can be used by 2, 3 or 4 Sounds in setting up velocity crossfading, whereby a different Sound is played depending on how hard or soft the keyboard is played.

As explained earlier, many of the samples from which you can choose when assigning voices are already "velocity-switching". These samples usually have the word "Velo" or the letter "V" in their names, indicating that there is actually more than one sample per note which can be selected by how hard or soft each note is played. However, the velocity point at which these sounds change is fixed and cannot be altered. If you want to create your own velocity-crossfading Program, assign the single-sample versions of the same samples ("MarimbaVel" is made up of "Marimba Hd" and "Marimba Sf") to two or more Sounds, then use the appropriate velocity curves for each Sound (in a three-way velocity split, Sound 1 would use curve "1 of 3," Sound 2 would use curve "2 of 3" while Sound 3 would use "3 of 3").

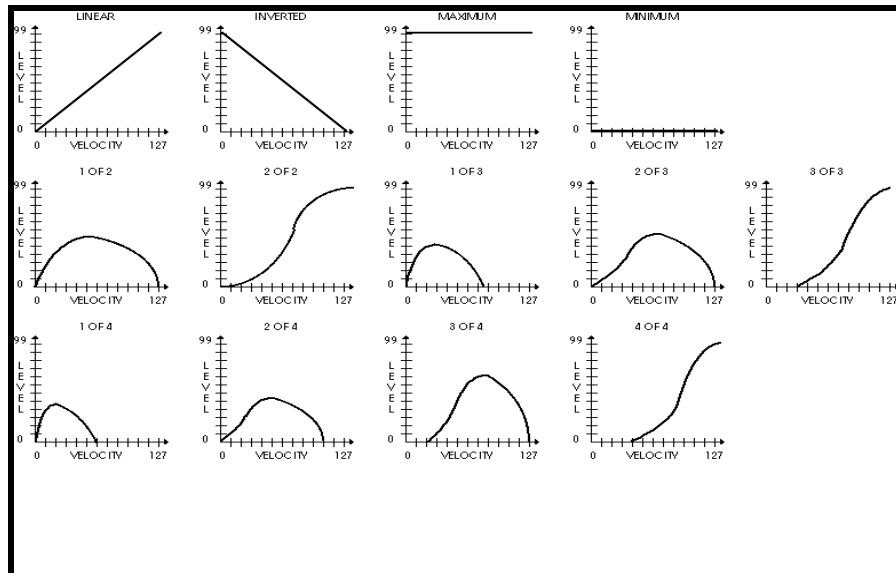

**TIP:** You can create your own custom velocity curves using the Tracking Generator and the Mod section. It's easier to do this if you select the MINIMUM curve. Then select an available Mod (say Mod 1, or button [0]), and on page 1 select TRACKGEN as your source. On page 2 select Amplitude as your destination, and then set the level to +99 on page 3. On button [9], page 1, select Velocity as your Input and then experiment with the ways different numbers affect the velocity response as you input values for Points 0-10. See pages 139-142, 149 and 150 for more information.

### Aftertouch Depth (-99 to +99)

Page 2

At +00, aftertouch has no effect on the amplitude. Applying aftertouch with this parameter set to a positive value raises the amplitude; conversely, applying aftertouch with a negative value will make the sound softer the harder you press. The higher the number (either positive or negative), the greater the effect for a given amount of aftertouch.

**TIP:** Use aftertouch to “swell” the amplitude of string and horn parts. But please note: Notes played at maximum velocity will probably not have the “headroom” available for a positive-going amplitude swell. Try playing some soft, medium, and loud notes while experimenting with this parameter.

### Amp LFO Depth (-99 to +99)

Page 3

At +00, the Amp LFO has no effect. Higher positive values increase the amount of LFO modulation. Negative values give the same apparent effect, but with reversed LFO phase (i.e., if the amplitude would normally be increasing with depth set to a positive number, the amplitude would instead be decreasing at that same moment had the depth been set to a negative number). Amp LFO parameters (such as speed and wave shape) are programmed within the Amp LFO Function on button [8] (see pages 147-148).

Note: If you hear no change when you alter this parameter, spend some time experimenting with the Amp LFO Functions on button [8].

Another note: If your Amplitude LFO is using the Square, Up Saw, Down Saw, or Random+ waveshapes, you may get a more pronounced effect if you use a negative setting for Amp LFO Depth. See page 144 for more information about the various LFO waveshapes.

**TIP:** Amp LFO set to a triangle wave gives tremolo effects.

**Lower Limit (MIDI note 000 to 127/ C-2 to G8)**

**Page 4**

Each Sound can be restricted to a specific range of the keyboard. This is ideal for creating splits (e.g., bass on the lower keys, piano in the middle, and strings in the upper octave).

The Lower Limit specifies the lowest note of the Sound’s keyboard range. You can set the lower limit when you’re on this page by holding [80] and tapping a key on the keyboard.

**High Limit (MIDI note 000 to 127/ C-2 to G8)**

**Page 5**

Specifies the highest note of the Sound’s keyboard range. You can set the high limit when you’re on this page by holding [80] and tapping a key on the keyboard.

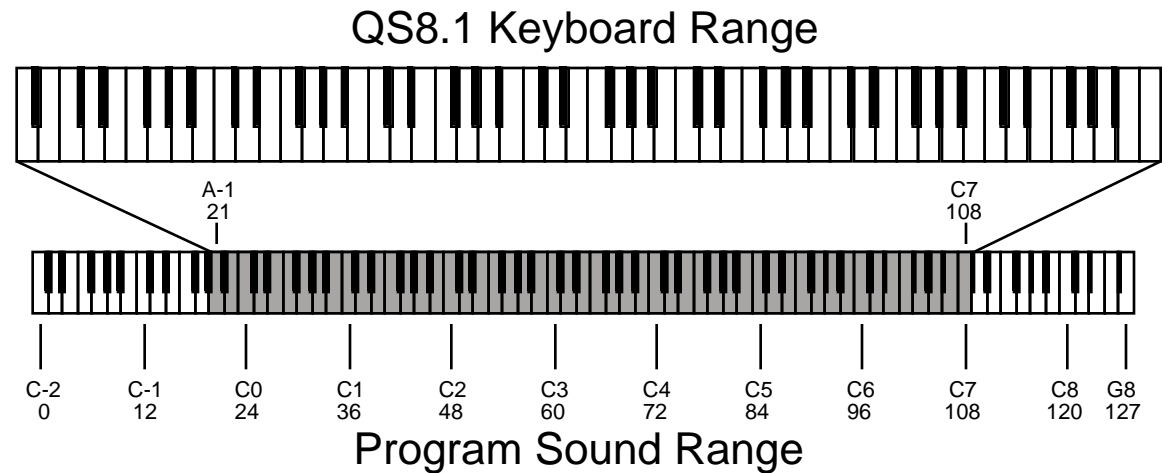

**TIP.** By setting the lower limit above the high limit, you can create a “hole in the middle” effect. This makes the Sound appear to have two zones. All notes from the bottom of the keyboard to the high limit note will play, and all notes from the lower limit note to the top of the keyboard will play, but the notes between the high limit and the lower limit will not play. This can be further enhanced in Mix Mode by using the Range function in Mix Edit Mode to cap-off the low and high limits.

## Sound Overlap (00 to 99)

This determines how many voices can overlap on the same pitch. *Example:* If you hold the sustain pedal down and play the same note over and over, Sound Overlap determines how many voices are available for that note, and thus how many voices will overlap (play simultaneously).

In the old days, different brands of synthesizers offered different voice allocation schemes. One brand used a method called “rotate mode” in which each time a note was struck, a new voice was used. Another brand used a different method called “reassign mode” whereby if a note is played and then played again, the same voice is used both times. In other words, a new voice is used each time a new note of a different pitch is played.

The Sound Overlap value lets you choose a comfortable setting between rotate mode and reassign mode. When the value equals 99, you are always in rotate mode, using up polyphony; if the value is 00, you are always in reassign mode, conserving voices. Set the value anywhere between 00 and 99 and you will get a combination of both, with partiality toward whichever mode the value is closest to.

A piano sound requires some Sound Overlap, but not a lot; it isn’t natural to hear too many voices on the same note. On the other hand, having only one voice per pitch isn’t natural either; let’s say you played a loud note with the sustain pedal held, followed by a soft note--the second note would abruptly cut off the first. On a real piano, the string would still be resonating from the first (loud) note when the second (soft) note was played; thus the two notes would overlap.



*It is important to note that Sound Overlap can have a negative effect on polyphony.*

If you have Sound Overlap set to 99, hold the sustain pedal and play a series of notes, you will run through all 64 voices in no time. By adjusting the Sound Overlap to a lower value, you decrease the number of voices used by each new note, and thereby ensure there are voices available to play other sounds, if necessary.

## PITCH ENVELOPE

The Pitch Envelope function (press [90]) can lead to dramatic effects, since it can cause the pitch of a single key to change drastically over time. It's typically used in special-effect synthesizer programs, but it may also be used more subtly in an acoustic program to simulate the characteristic of some instruments to go sharp on the initial attack, especially when played hard.



*The following Pitch Envelope variables will have an effect only if the PITCH ENVELOPE DEPTH (on Page 7 of the PITCH function) is set to a value other than 0, or if Pitch Envelope is a source in the MOD function.*

### Attack (00 to 99)

Page 1

This is the amount of time the envelope will take until it reaches its maximum output level. Setting the Attack to 0 will make the pitch go to maximum immediately on hitting the key (if the Delay is also set to 0 in Pitch Envelope, Page 5 -- see next page); a setting of 99 will result in a much slower attack, taking many seconds before the envelope gets to maximum.

### Decay & Sustain (00 to 99)

Pages 2 & 3

As soon as the attack portion of the envelope finishes (when the level reaches maximum), the envelope will decay (decrease in level). The level it reaches is set by the Sustain control; how long it takes to get there is set by the Decay control. In the special case where the Sustain level is all the way up (99), then there is no decrease and the Decay time segment is bypassed. Depending on the setting of the Sustain Decay control (see below), the envelope will either hold at the sustain level until you release the note on the keyboard, or decay to 0 at the Sustain Decay rate (which is on page 6 of the envelope function). You can create a long "plateau" at the start of a note by setting the Sustain to 98 and the Decay to 99. This will cause the envelope to take the maximum amount of time to get from peak level to a level of 98, before the Sustain Decay portion of the envelope begins.

### Release (00 to 99, Hold)

Page 4

Eventually, you will let go of the note that you've been holding (either by releasing the note on the keyboard, or releasing the sustain pedal if it was pressed). It is at this point that the Release portion of the envelope takes effect. The Release is the time that the envelope takes to get from its current level back down to nothing. Setting the Release time to 99 will make the envelope take a very long time to reach zero level.

The Pitch Envelope is unique from the other two envelopes in that its Release time can be set above 99. When this is done, the value in the display will read "Hold". This indicates that the Pitch Envelope will remain where it is even after the note is released. This is important when you want the pitch effect to continue even after releasing the key. *Example:* If the Pitch Envelope is bending a note up, and you don't want the pitch to fall when you release the key, set the Release parameter to "Hold".

**Delay (00 to 99, Hold)****Page 5**

This is the amount of time that the envelope will wait before doing anything; very useful if you want to affect one element of a sound sometime after the sound starts. When the Delay is set to 0, the envelope begins its attack segment right away, without any delay. Play some notes while turning up the delay and see that the time between playing the note and hearing the effect of the Pitch Envelope gets progressively longer as the Delay control is turned up.

If the Delay is set above 99, the display will read "Hold". This indicates that the Delay stage of the envelope will wait indefinitely until the key is released before continuing on to the remaining envelope stages (Attack, Decay, etc.). With a value of "Hold", the Pitch Envelope's Trigger parameter is automatically set to "Freerun" in the software (see below). However, the displayed value of that parameter is not changed; only its behavior is.

**Sustain Decay (00 to 99)****Page 6**

This is the amount of time that the envelope will take during the sustain stage to bring the level down to 0. If this is set to 99, the envelope will remain at the Sustain level until the note is released. When set to 0, the envelope's level will immediately jump down to 0 upon reaching the sustain stage.

**Trigger (Normal, Freerun, Reset, Reset-Freerun)****Page 7**

The Trigger mode determines how the envelope will function. You may select either Freerun or Reset, or both (Reset-Freerun) or neither (Normal). When set to Normal, the envelope will always start at its current level (i.e., if another note had been played which triggered the envelope's cycle, playing another note in the middle would not interrupt the cycle). Also in Normal mode, the envelope will immediately advance to its release stage upon releasing the note. When set to Freerun, the envelope will complete its entire cycle, even if the note is released in the middle. When set to Reset, the envelope starts at the beginning whenever a new note is played. When set to Reset-Freerun, the envelope will start at the beginning whenever a new note is played and will complete its entire cycle, even if the note is released in the middle.

If a Sound layer's Keyboard Mode parameter (found in the Pitch Function, Page 10) is set to "Mono", the Pitch Envelope will only retrigger when playing legato if the Trigger Mode is set to either "Reset" or "Reset-Freerun".

**Time Tracking (On or Off)****Page 8**

This determines whether or not keyboard position will affect the cycle speed of the envelope. When turned on, playing toward the higher end of the keyboard will result in a faster envelope cycle; playing toward the lower end of the keyboard will result in a slower envelope cycle. However, this does not affect the attack time, but only the decay, sustain decay and release segments. This feature will result in only a subtle change. The envelope's timing doubles or halves over a range of two octaves.



**Sustain Pedal (On or Off)****Page 9**

This determines whether or not the Sustain Pedal will have an effect on the envelope. When turned on, holding down the Sustain Pedal while playing short notes is virtually the equivalent to holding down those notes on the keyboard with some subtle but important differences. If the Delay and Attack are set to 0 and either the Decay is 0 or the Sustain is 99, the envelope will immediately jump to the sustain decay stage (if not already there) when the note is released and the sustain pedal is held down. If a long attack is set, and the envelope has not reached the end of the attack segment when the note is released, the envelope will jump immediately to the Sustain Decay segment. If a long delay is set, and the envelope has not reached the attack segment before the note is released, the envelope will remain at 0. However, if Freerun is turned on, the envelope will continue through the delay, attack, decay and sustain segments and remain at the sustain decay segment. This is exactly the same as holding down the note on the keyboard. When the Sustain Pedal parameter is turned off, the Sustain Pedal will have no effect on the envelope.

**Level (00 to 99)****Page 10**

This is the overall output level of the envelope. If this is set to 00, the Pitch Envelope will have no output and will have no effect, while at 99 it will have a maximum effect on whatever it is being routed to.

**TIP.** When selecting Pitch Envelope Level as a modulation destination, set the Pitch Envelope level to 00 if the Modulation Level is above 0 (or, set the Pitch Envelope level to 99 if the Modulation Amount is below 0).

**Velocity Modulation (00 to 99)****Page 11**

This parameter is called VEL>PLevel in the display. It determines how keyboard dynamics will affect the envelope level. When set to 99, note velocity controls the envelope's output; notes played hard will deliver a higher envelope output than notes played soft. When set to 0, note velocity will have no effect on the envelope's output level.

Note: If the Penv Level is at 99, a positive value of any sort for VEL>PLevel will have no effect. Likewise, if VEL>PLevel is at 99 and Penv Level is at 00, only low velocity notes will allow a difference to be heard when you change the Penv Level value. This is because the Pitch Envelope cannot reach an output level higher than 99. You must add the Penv Level and VEL>PLevel values together to know if you are trying to exceed that limit. So, if you have a Penv Level value of 40, you have enough headroom in the Pitch Envelope to set VEL>PLevel to 59. But if the Penv Level is set to 70 and VEL>PLevel is at 45, you're trying to get the Pitch Envelope to give an output of 115 (which it can't do). In this scenario, you should scale back one or the other (or both) until their combined values do not exceed 99.

## FILTER ENVELOPE

The Filter Envelope function (press [100]) is crucial whenever you want the tonal quality of a note to change over time, differently from its overall level. *Example:* When you want the initial attack of a note to be bright, but want the sustaining part to be filtered.

Note: Be sure to read the TIP in the Filter Envelope Trigger Mode section on page 134. It deals with getting the most natural interaction between the Sustain Pedal and the Filter Envelope.

**TIP.** For the most effective Filter Envelope sweeps, leave the Amplitude Envelope Sustain level at maximum (99) and control the shape of the Sound entirely with the Filter envelope (especially the Decay rate and Sustain level).



*The following Filter Envelope variables will have effect only if the FILTER ENVELOPE DEPTH (on Page 7 of the FILTER function) is set to a value other than 0, or Filter Envelope is a source in the MOD function.*

*Also note that the Filter Envelope may have no effect if some other modulation source, or the basic setting of the filter, has already pushed the filter cutoff frequency to its maximum.*

### Attack (00 to 99)

Page 1

This is the amount of time the envelope will take until it reaches its maximum output level. Setting the Attack to 0 will give a sharp edge to the sound (if the Delay is also set to 0 in Filter Envelope Page 5 -- see next page); a setting of 99 will result in a much slower attack, taking many seconds before the envelope gets to maximum.

### Decay & Sustain (00 to 99)

Pages 2 & 3

As soon as the attack portion of the envelope finishes (when the level reaches maximum), the envelope will decay (decrease in level). The level it reaches is set by the Sustain control; how long it takes to get there is set by the Decay control. In the special case where the Sustain level is all the way up (99), then there is no decrease and the Decay time segment is bypassed. Depending on the setting of the Sustain Decay control (see below), the envelope will either hold at the sustain level until you release the note on the keyboard, or decay to 0 at the Sustain Decay rate (which is on page 6 of the envelope function). You can create a long "plateau" at the start of a note by setting the Sustain to 98 and the Decay to 99. This will cause the envelope to take the maximum amount of time to get from peak level to a level of 98, before the Sustain Decay portion of the envelope begins.

### Release (00 to 99)

Page 4

Eventually, you will let go of the note that you've been holding (either by releasing the note on the keyboard, or releasing the sustain pedal if it was pressed). It is at this point that the Release portion of the envelope takes effect. The Release is the time that the envelope takes to get from the sustain level back down to nothing. Setting the Release time to 0 is good for playing those short funky riffs that you hear on a clavinet. Setting the Release time to 99 will make the envelope take a very long time to reach zero level.

**Delay (00 to 99)****Page 5**

This is the amount of time that the envelope will wait before doing anything; very useful if you want to affect one element of a sound sometime after the sound starts. When the Delay is set to 0, the envelope begins its attack segment right away, without any delay. Play some notes while turning up the delay and see that the time between playing the note and hearing the effect of the Filter Envelope gets progressively longer as the Delay control is turned up.

If the Delay is set above 99, the display will read "Hold". This indicates that the Delay stage of the envelope will wait indefinitely until the key is released before continuing on to the remaining envelope stages (Attack, Decay, etc.). With a value of "Hold", the Pitch Envelope's Trigger parameter is automatically set to "Freerun" in the software (see below). However, the displayed value of that parameter is not changed; only its behavior is.

**Sustain Decay (00 to 99)****Page 6**

This is the amount of time that the envelope will take during the sustain stage to bring the level down to 0. If this is set to 99, the envelope will remain at the Sustain level until the note is released. This is the normal setting for organ-type sounds. When set to 0, the envelope's level will immediately jump down to 0 upon reaching the sustain stage.

**Trigger (Normal, Freerun, Reset, Reset-Freerun)****Page 7**

The Trigger mode determines how the envelope will function. You may select either Freerun or Reset, or both (Reset-Freerun) or neither (Normal). When set to Normal, the envelope will always start at its current level (i.e., if another note had been played which triggered the envelope's cycle, playing another note in the middle would not interrupt the cycle). Also in Normal mode, the envelope will immediately advance to its release stage upon releasing the note. When set to Freerun, the envelope will complete its entire cycle, even if the note is released in the middle. When set to Reset, the envelope starts at the beginning whenever a new note is played. When set to Reset-Freerun, the envelope will start at the beginning whenever a new note is played and will complete its entire cycle, even if the note is released in the middle.

If a Sound layer's Keyboard Mode parameter (found in the Pitch Function, Page 10) is set to "Mono", the Filter Envelope will only retrigger when playing legato if the Trigger Mode is set to either "Reset" or "Reset-Freerun".

**TIP.** To get the most natural-sounding Sustain Pedal reaction, the best setting for the Filter Envelope Trigger Mode is usually either the FREERUN or the RESET-FREERUN mode. This allows the Filter to keep following its envelope shape even after the keys are lifted up.

**Time Tracking (On or Off)****Page 8**

This determines whether or not keyboard position will affect the cycle speed of the envelope. When turned on, playing toward the higher end of the keyboard will result in a faster envelope cycle; playing toward the lower end of the keyboard will result in a slower envelope cycle. However, this does not affect the attack time, but only the decay, sustain, sustain decay and release segments. This feature will result in only a subtle change. The envelope's timing doubles or halves over a range of two octaves.

**Sustain Pedal (On or Off)****Page 9**

This determines whether or not the Sustain Pedal will have an effect on the envelope. When turned on, holding down the Sustain Pedal while playing short notes is virtually the equivalent to holding down those notes on the keyboard with some subtle but important differences. If the Delay and Attack are set to 0 and either the Decay is 0 or the Sustain is 99, the envelope will immediately jump to the Sustain Decay stage (if not already there) when the note is released and the sustain pedal is held down. If a long attack is set, and the envelope has not reached the end of the attack segment when the note is released, the envelope will jump immediately to the sustain decay segment. If a long delay is set, and the envelope has not reached the attack segment before the note is released, the envelope will remain at 0. However, if Freerun is turned on, the envelope will continue through the delay, attack, decay and sustain segments and remain at the sustain decay segment. This is exactly the same as holding down the note on the keyboard. When the Sustain Pedal parameter is turned off, the Sustain Pedal will have no effect on the envelope.

**Level (00 to 99)****Page 10**

This is the overall output level of the envelope. If this is set to 00, the Filter Envelope will have no output and will have no effect, while at 99 it will have a maximum effect on whatever it is being routed to.

**TIP.** When selecting Filter Envelope Level as a modulation destination, set the Filter Envelope level to 00 if the Modulation Level is above 0 (or, set the Filter Envelope level to 99 if the Modulation Amount is below 0).

**Velocity Modulation (00 to 99)****Page 11**

This parameter is called VEL>FLevel in the display. It determines how keyboard dynamics will affect the envelope level. When set to 99, note velocity controls the envelope's output; notes played hard will deliver a higher envelope output than notes played soft. When set to 0, note velocity will have no effect on the envelope's output level.

Note: If the Fenv Level is at 99, a positive value of any sort for VEL>FLevel will have no effect. Likewise, if VEL>FLevel is at 99 and Fenv Level is at 00, only low velocity notes will allow a difference to be heard when you change the Fenv Level value. This is because the Filter Envelope cannot reach an output level higher than 99. You must add the Fenv Level and VEL>FLevel values together to know if you are trying to exceed that limit. So, if you have a Fenv Level value of 40, you have enough headroom in the Filter Envelope to set VEL>FLevel to 59. But if the Fenv Level is set to 70 and VEL>FLevel is at 45, you're trying to get the Filter Envelope to give an output of 115 (which it can't do). In this scenario, you should scale back one or the other (or both) until their combined values do not exceed 99.

## **AMP ENVELOPE**

The Amp Envelope function (press [110]) is crucial for all sounds because it sets the basic characteristics of the note--whether it attacks quickly or slowly, sustains or decays. Some Programs may leave the Amp Envelope in a sustaining mode, and provide attack and decay using the Filter Envelope; the effect is slightly different. Unlike the Pitch and Filter Envelopes, the Amp Envelope is always fully active (there is no parameter in the Amp/Range function adjusting how much envelope is applied to the Amp).

### **Attack (00 to 99)**

**Page 1**

This is the amount of time the envelope will take until it reaches its maximum output level. Setting the Attack to 0 will give a sharp edge to the sound (if the Delay is also set to 0 in Amp Envelope Page 5 -- see below); a setting of 99 will result in a much slower attack, taking many seconds before the envelope gets to maximum.

### **Decay & Sustain (00 to 99)**

**Pages 2 & 3**

As soon as the attack portion of the envelope finishes (when the level reaches maximum), the envelope will decay (decrease in level). The level it reaches is set by the Sustain control; how long it takes to get there is set by the Decay control. In the special case where the Sustain level is all the way up (99), then there is no decrease and the Decay time segment is bypassed. Depending on the setting of the Sustain Decay control (see below), the envelope will either hold at the sustain level until you release the note on the keyboard, or decay to 0 at the Sustain Decay rate (which is on page 6 of the envelope function). You can create a long "plateau" at the start of a note by setting the Sustain to 98 and the Decay to 99. This will cause the envelope to take the maximum amount of time to get from peak level to a level of 98, before the Sustain Decay portion of the envelope begins.

### **Release (00 to 99)**

**Page 4**

Eventually, you will let go of the note that you've been holding (either by releasing the note on the keyboard, or releasing the sustain pedal if it was pressed). It is at this point that the Release portion of the envelope takes effect. The Release is the time that the envelope takes to get from the sustain level back down to nothing. Setting the Release time to 0 is good for playing those short funky riffs that you hear on a clavinet. Setting the Release time to 99 will make the envelope take a very long time to reach zero level.

### **Delay (00 to 99)**

**Page 5**

This is the amount of time that the envelope will wait before doing anything; very useful if you want to affect one element of a sound sometime after the sound starts. When the Delay is set to 0, the envelope begins its attack segment right away, without any delay. Play some notes while turning up the delay and see that the time between playing the note and hearing the effect of the Amp Envelope gets progressively longer as the Delay control is turned up.

If the Delay is set above 99, the display will read "Hold". This indicates that the Delay stage of the envelope will wait indefinitely until the key is released before continuing on to the remaining envelope stages (Attack, Decay, etc.). With a value of

“Hold”, the Pitch Envelope’s Trigger parameter is automatically set to “Freerun” in the software (see below). However, the displayed value of that parameter is not changed; only its behavior is.

### **Sustain Decay (00 to 99)**

**Page 6**

This is the amount of time that the envelope will take during the sustain stage to bring the level down to 0. If this is set to 99, the envelope will remain at the Sustain level until the note is released. When set to 0, the envelope’s level will immediately jump down to 0 upon reaching the sustain stage.

### **Trigger (Normal, Freerun, Reset, Reset-Freerun)**

**Page 7**

The Trigger mode determines how the envelope will function. You may select either Freerun or Reset, or both (Reset-Freerun) or neither (Normal). When set to Normal, the envelope will always start at its current level (i.e., if another note had been played which triggered the envelope’s cycle, playing another note in the middle would not interrupt the cycle). Also in Normal mode, the envelope will immediately advance to its release stage upon releasing the note. When set to Freerun, the envelope will complete its entire cycle, even if the note is released in the middle. When set to Reset, the envelope starts at the beginning whenever a new note is played. When set to Reset-Freerun, the envelope will start at the beginning whenever a new note is played and will complete its entire cycle, even if the note is released in the middle. If a Sound layer’s Keyboard Mode parameter (found in the Pitch Function, Page 10,) is set to “Mono”, the Amp Envelope will only retrigger when playing legato if the Trigger Mode is set to either “Reset” or “Reset-Freerun”.

### **Time Tracking (On or Off)**

**Page 8**

This determines whether or not keyboard position will affect the cycle speed of the envelope. When turned on, playing toward the higher end of the keyboard will result in a faster envelope cycle; playing toward the lower end of the keyboard will result in a slower envelope cycle. However, this does not affect the attack time, but only the decay, sustain, sustain decay and release segments. This feature will result in only a subtle change. The envelope’s timing doubles or halves over a range of two octaves.

### **Sustain Pedal (On or Off)**

**Page 9**

This determines whether or not the Sustain Pedal will have an effect on the envelope. When turned on, holding down the Sustain Pedal while playing short notes is virtually the equivalent to holding down those notes on the keyboard with some subtle but important differences. If the Delay and Attack are set to 0 and either the Decay is 0 or the Sustain is 99, the envelope will immediately jump to the release stage (if not already there) when the note is released and the sustain pedal is held down. If a long attack is set, and the envelope has not reached the end of the attack segment when the note is released, the envelope will jump immediately to the sustain decay segment. If a long delay is set, and the envelope has not reached the attack segment before the note is released, the envelope will remain at 0. However, if Freerun is turned on, the envelope will continue through the delay, attack, decay and sustain segments and remain at the sustain decay segment. This is exactly the same as holding down the note on the keyboard. When the Sustain Pedal parameter is turned off, the Sustain Pedal will have no effect on the envelope.

**Level (00 to 99)**

This is the overall output level of the envelope. If this is set to 00, the Amp Envelope will have no output and will have no effect, while at 99 it will have a maximum effect on whatever it is being routed to.

**TIP.** When selecting Amp Envelope Level as a modulation destination, set the Amp Envelope level parameter to 01 if the Modulation Level is above 0 (or, set the Amp Envelope level to 99 if the Modulation Amount is below 0).

*Note: If you're new to synth programming, don't feel bad if you don't understand the next few sentences. But if you're a MIDI wind player and/or want to set up level control of one Sound from one of the sliders, you'll want to delve into this subject when you're ready.*

That last TIP is a tricky one! Make sure your negative modulation amount is not greater than the Aenv Level setting mentioned above. For example: If your Aenv Level is at 59 and you have Controller A routed to AENV AMP with a mod amount of -60 in one of the Mods (see the Mod 1 - Mod 6 section ahead), any note held down when Controller A reaches its maximum throw will be released by the software and will be unable to be pulled back up by Controller A. You'll have to re-trigger the note. This is because the held note has crossed its zero-point in its Amplitude, and is assumed by the QS to be available for some other use. But if your Aenv Level is at 60 and Controller A is routed to it in a negative amount of -60, the maximum throw of the slider will not take the held note below the zero-point, and you will be able to bring it back up.

**NAME**

The Name Function (press [120]) allows you to change the Program's name. The Program name can be up to 10 characters long. Use the [◀ PAGE] and [PAGE ▶] buttons to position the cursor. The [▲ VALUE]/[VALUE ▼] buttons and the CONTROLLER [D] slider let you change the character. Here is a chart of available characters:

	!	"	#	\$	%	&	'	(	)	*	+	,	-	.	/	0	1	2	3
4	5	6	7	8	9	:	;	<	=	>	?	@	A	B	C	D	E	F	G
H	I	J	K	L	M	N	O	P	Q	R	S	T	U	V	W	X	Y	Z	[
¥	]	^	_	`	a	b	c	d	e	f	g	h	i	j	k	l	m	n	o
p	q	r	s	t	u	v	w	x	y	z	{		}						

## MOD 1 – MOD 6

### About General Purpose Modulation

Although there are several dedicated modulators in the QS (e.g., the pitch can always be modulated by the pitch LFO and Pitch Envelope), sophisticated synthesizer programming demands the ability to use as many modulation sources as possible to modulate as many modulation destinations as desired.

The QS arranges its modulation source outputs and modulation destination inputs into a “matrix” so that any selected source can connect to any of several destinations.

There are six general purpose matrix modulators, which allows you to control up to six parameters with any of several control sources.

Use the MOD functions to setup your own customized control of a program, such as:

- Using the PEDAL 1 input or the Controller A Slider to control volume, brightness (filter cutoff), effect level, LFO speed, etc.
- Using velocity to increase or decrease the attack speed of an envelope, so playing softly makes the sound fade in, while playing hard causes an immediate attack.
- Using release velocity to increase/decrease the release time of an envelope, so quick releases of the keys cut off the end of the sound, while slow key releases allow the sound to fade away gradually.

The MOD functions give you the freedom to go beyond the standard modulation sources built-in to other functions.

Note: Six Mods may seem like a lot, but once you run out, you're going to wish you had more! One way to extend the power of your Mod section is to be sure you're not routing something with a Mod that could be handled elsewhere in the QS's functions. Here's a list of routings which we "hardwired" into the synth to free up Mods:

Source	Destination	Location	Notes
Aftertouch	Pitch(bend)	PITCH pg. 5	
	Filter frequency	FILTER pg. 5	
	Amplitude	AMP/RANGE pg. 2	
	Pitch LFO depth	PITCH LFO pg. 7	
	Filter LFO depth	FILTER LFO pg. 7	
Mod Wheel	Amplitude LFO depth	AMP LFO pg. 7	
	Filter frequency	FILTER pg. 4	
	Pitch LFO depth	PITCH LFO pg. 6	
	Filter LFO depth	FILTER LFO pg. 6	
Velocity	Amplitude LFO depth	AMP LFO pg. 6	
	Filter frequency	FILTER pg. 3	
Note Number	Filter frequency	FILTER pg. 2	On/Off
	Envelope decay/sustain decay/release time	P/F/AENV pg. 8	On/Off*



\* If you want finer control over the way the envelope tracks the keyboard than is afforded by the TRACK: ON/OFF parameter, then you can use a mod routing to do it. But please compare the two ways so you're sure there's a significant difference before sacrificing a mod routing to do keyboard/envelope tracking.

### Selecting the Modulator (1 to 6)

Use the [0] – [5] buttons to select one of the six modulators (modulator 1 is [0], modulator 2 is [1], modulator 3 is [2], etc.). All modulators work in the same way, so only the pages of one will be described here.

Note: When you're on one of the pages within a Mod, the top of the display will show you whether or not that Mod is active. If the Level parameter for a Mod is set to 00, you'll see the word "mod" on the top line in small letters (because the mod is disabled). But as soon as you change the Level, the word "mod" will be capitalized (so "mod 1 becomes MOD 1", etc.). This way you can tell at a glance whether or not a Mod is active, without having to look at the Level page.

### Modulation Source

Page 1

Note: Remember that these can be routed negatively, also. For example, Velocity doesn't have to increase something when you play harder. Things can be made to *decrease* when you play harder.

Select from the following modulation sources:

- **Note #** provides a modulation signal that corresponds to the note played on the keyboard (higher keys give higher values). Example: Use this modulation source to obtain a different chorus sound in the upper and lower keyboard ranges.
- **Velocity** relates to how fast a key goes from the key up (note off) to the key down (note on) position (or, how hard you hit it), and therefore represents the dynamics of your playing.
- **Release velocity** relates to how fast a key goes from the key down (note on) to the key up (note off) position. Example: Use this to affect the rate of a sound's release based on how quickly you remove your fingers from the keys.
- **Aftertouch** Pressing on the keys after they're down generates this control signal. Aftertouch is also called channel pressure, and represents an average of all keys being pressed. This affects any keys that are held down. The harder you press on the keys, the greater the degree of modulation.
- **Polyphonic Pressure** This is similar to aftertouch, but each key can respond to individual pressure messages. Although the QS keyboard does not generate poly pressure, its internal sound generators can respond to poly pressure signals entering via the MIDI Input or serial port. *Example:* Assign poly pressure to the sound's amplitude in a string ensemble patch. You can then increase the level of selected notes of a held chord to "pull" some notes out of the chord.
- **Modulation Wheel** The rightmost wheel, Modulation, is traditionally assigned to LFO amount (level) so that rotating the wheel away from you introduces vibrato. However it is also well-suited to controlling timbre, vibrato speed, and many other parameters.

- **Pitch Wheel** The leftmost wheel, Pitch, usually controls the oscillator pitch but can be tied to other parameters as well.
- **MIDI Volume** MIDI can produce a variety of controller messages (see the MIDI supplement in the back of this manual). Of these, controller #7, which controls channel volume, is one of the most frequently used. Example: Assign the filter cutoff as the destination, and you can have the signal become less bright as it becomes lower in volume.
- **Sustain Pedal** The sustain switch plugged into the sustain pedal jack provides this modulation signal.
- **Pedal 1** The default setting assigns Pedal 1 to MIDI Controller 7 to act as a volume pedal. But it can also be assigned to any other incoming MIDI controller number (Global Edit Mode, page 12) and routed to any destination in the Mod section.
- **Pedal 2** Even if you're not using a "Pedal 2," it is still available in the Global section as an assignable controller (Global Edit Mode, page 13). This parameter is what enables you to select that incoming MIDI controller as a source for modulation.
- **Pitch LFO/Filter LFO/Amplitude LFO:** You can select the LFOs as modulation sources, even if they aren't being used to affect the Sound in their usual ways. Once selected, you can route them to affect some unusual things -- like each other! Any item on the Destination list is fair game.
- **Pitch Envelope/Filter Envelope/Amplitude Envelope:** These can also be selected as modulation sources. Try routing them to LFO speeds or the Effect Send Level of a Sound, or whatever you can think up!
- **Random** This provides a different modulation value every time you hit a key. Example: With vintage analog synth patches, use pitch as the destination and apply a very slight amount of random modulation. Each note will have a slightly different pitch, which simulates the natural tuning instability of analog circuits.
- **Trigrate** This is a Trigger Rate Follower, which monitors how fast notes are being played on the keyboard. For example, if routed to the Effect send of a Program, you could automatically have more effect when playing slowly, and less effect when playing quickly (or vice versa).
- **Controllers (A, B, C, D)** Four incoming MIDI controllers can be recognized by the QS and used as modulation sources. These controllers are assigned as A-D in Global Edit Mode (pages 8-11). In Program Play and Mix Play Modes, the CONTROLLER [A], [B], [C] and [D] sliders serve the same purpose.
- **Tracking Generator** This accepts the output of a signal processed by the Tracking Generator module (see page 149).
- **Stepped Tracking Generator** This accepts the output of a signal processed by the Tracking Generator module in stepped mode (see page 150).

**Modulation Destination****Page 2**

Select from the following modulation destinations. You can find out more about these parameters and how they affect the sound in their respective sections (for example: to learn how Pitch Envelope Attack affects the sound, see page 130 on Pitch Envelopes):

- Pitch
- Filter Cutoff
- Amplitude
- Effect Send
- Pitch LFO Speed
- Pitch LFO Amp
- Pitch LFO Delay
- Pitch Envelope Delay
- Pitch Envelope Attack
- Pitch Envelope Decay
- Pitch Envelope Sus. Decay
- Pitch Envelope Release
- Pitch Envelope Amp
- Filter LFO Speed
- Filter LFO Amp
- Filter LFO Delay
- Filter Envelope Delay
- Filter Envelope Attack
- Filter Envelope Decay
- Filter Envelope Sus. Decay
- Filter Envelope Release
- Filter Envelope Amp
- Amp LFO Speed
- Amp LFO Amp
- Amp LFO Delay
- Amp Envelope Delay
- Amp Envelope Attack
- Amp Envelope Decay
- Amp Envelope Sus. Decay
- Amp Envelope Release
- Amp Envelope Amp
- Portamento Rate

Note: "Amp Envelope Amp" is also known as Aenv Level (Amp Envelope function, page 10). For a discussion on using it as a destination, see the TIP on page 138.

Yet Another Note: When Portamento Rate is chosen as a destination, you will hear no change in that parameter unless it is at least set to 01 (Pitch function, page 9; or see page 121 in this chapter).

**Modulation Level (-99 to +99)****Page 3**

At +00, the modulation source has no effect on the destination. Higher positive values increase the amount of modulation. Negative values also increase the amount of modulation, but with negative phase (i.e., if the modulation would normally be increasing with depth set to a positive number, the modulation would instead be decreasing at that same moment had the depth been set to a negative number).

In other words, if you choose Controller A as your source and Pitch as your destination, a value here of +99 will cause the pitch to rise as slider A moves up. A value of -99 will lower the pitch as slider A moves up.

**TIP.** When modulating Pitch, a Mod level of +72 or -72 will give exactly one octave of modulation at maximum input.

**Gate Mode (Off or On)****Page 4**

The Gate Mode function is available only on modulation routings 1 through 3. When Gate Mode is on, the Modulator will only be routed while notes are being played. In other words, you can gate the effect of the Modulator so that it stops when you are not playing any notes. This can be used on sounds with medium to long release times, where an interesting effect (like tremolo) is intended to be active while holding notes down, but deactivated as the sound is fading away after being released. Or if you're using the Sustain pedal, you can have vibrato present until the keys are released, but have the notes hang on until the pedal is released.

### **Quantize Mode (Off or On)**

The Quantize Mode function is only available in modulation routings 4 through 6. When Quantize Mode is on, the modulation effect will be stepped. When off, the effect will be smooth, or linear. *Example:* If you were to route the Modulation Wheel to Pitch with an amplitude of +99, moving the Mod Wheel while the Quantize parameter was off would cause the pitch of a held note to slide up, much the same way it does when the Pitch Bend Wheel is used. However, moving the Mod Wheel while the Quantize parameter was on would cause the pitch of a held note to rise in half-step increments.

## PITCH LFO

The Pitch LFO function (press [6]) is most often used to apply vibrato to a Sound.



The following Pitch LFO variables will make a difference in the sound only if the PITCH LFO DEPTH (on Page 6 of the PITCH function) is set to a value other than 0, or, if the Pitch LFO is a source in the MOD function.

### Wave (8 choices)

Page 1

The waveform determines the shape of the LFO. Select either Sine, Triangle, Square, Up Saw, Down Saw, Random+-, Noise or Random+. Note that the two Sawtooth waves and the Random+ wave are unipolar (positive-going only) and the rest are bipolar (positive- and negative-going):

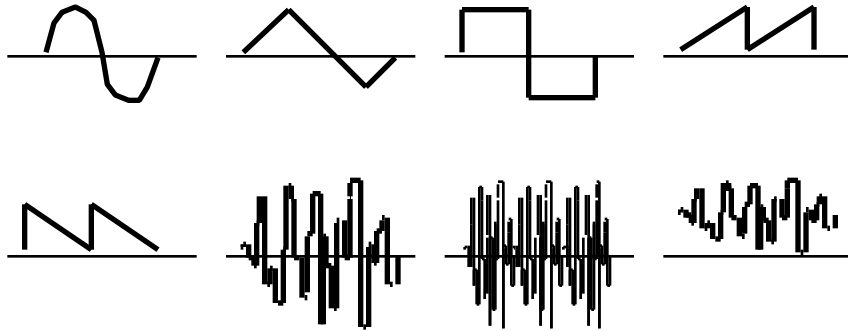

Note: The "unipolar" (positive-going) waveshapes tend to have a more noticeable impact on Filter and Amplitude if they are routed *negatively*. This is also true of the "Square" waveshape. To route them negatively, go to buttons [60], [70], and/or [80] (depending on what LFO you're working with) and call up page 6 with the [PAGE] buttons.

### Speed (00 to 99)

Page 2

Controls the speed or rate of the LFO. For fast modulation, increase this value. For slower modulation, decrease this value.

**Delay (00 to 99)**

Page 3

This sets the amount of time it takes the LFO to fade in from no modulation to maximum modulation. Sometimes, it is desirable to have modulation come in a moment or two after a note has been played, rather than starting instantly. The higher the value, the more slowly the LFO fades in.

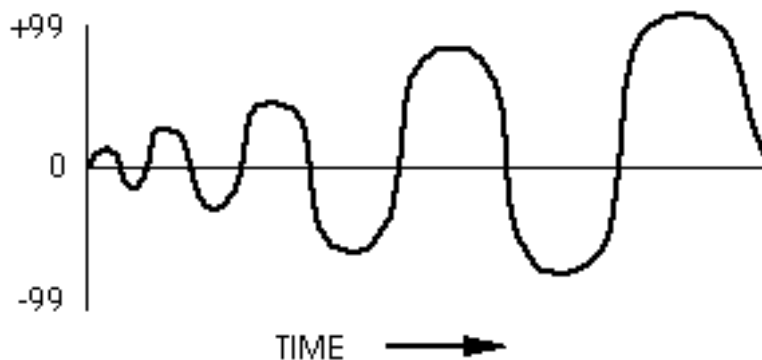
**Trigger (Mono, Poly, Key Mono, or Key Poly)**

Page 4

The Trigger parameter determines how the LFO should be triggered, or started. There are four possible settings: Mono, Poly, Key Mono and Key Poly. When playing multiple voices in a single Sound, each voice has its own LFO. However, the LFO Trigger parameter determines whether or not they should be in sync, and whether or not they can be retriggered independently from one another.

**Mono.** All voices' LFOs are in sync with each other. If you hold a chord and then play new notes on top of the chord, all voices' LFOs will be moving in the same direction and at the same speed.

Note: some modulation sources are by their very nature polyphonic, and can't be used to modulate the LFO speed when that LFO's Trigger mode is set to MONO. (You will be allowed to set up such Mod routings, but you won't hear any modulation of the LFO speed occur.) So if your LFO Trigger mode is set to MONO and you try to modulate it using Note Number, Velocity, Release Velocity, Pitch/Filter/ Amp LFO, Pitch/Filter/ Amp Envelope, Random, Trig Rate, Tracking Generator and/or STEPTRAK, nothing will happen. However, modulation sources which normally modulate an entire Sound at once will still have an effect while the LFO Trigger is set to MONO. In other words, if you have LFO Trigger mode set to MONO and you would like to be able to modulate the LFO's speed, use either Aftertouch, Mod Wheel, Pitch Wheel, MIDI Volume, Sustain Pedal, Pedal 1, Pedal 2, or one of the A-D Controllers as your source.

**Poly.** Each voice's LFO is independent. If you hold a chord, some voices' LFOs will be moving in one direction while others move in the other direction. If the LFO Speed is being modulated (by one of the envelopes, for example), the LFO's of each voice may be running at different speeds.

**Key Mono.** This is identical to MONO, but whenever a new note is played, the LFO is retriggered, instead of continuing from wherever it may be in its cycle.

**Key Poly.** This is almost identical to POLY, but whenever a new note is played, the LFO is retriggered, instead of continuing from wherever it may be in its cycle.

**Level (00 to 99)****Page 5**

This is the base output level of the Pitch LFO. If you want to have a constant value of vibrato, even without using the Mod Wheel or Aftertouch, set LEVEL above 00. The Mod Wheel and Aftertouch can add to or subtract from this base level. *Example:* If Level is set to 10 and the Mod Wheel parameter (see the next paragraph) is set to 10, there will always be some vibrato, and raising the Mod Wheel will add more vibrato. On the other hand, if the Mod Wheel parameter is set to -10, raising the Mod Wheel to the top will cancel out all vibrato.

**Mod Wheel Depth (-99 to 99)****Page 6**

This parameter sets how much the Mod Wheel will increase or decrease the Pitch LFO's Level. A positive value raises the level when the Mod Wheel is moved up, and lowers the level when it is moved down. Negative settings of this parameter will decrease the output level of the Pitch LFO as the Mod Wheel is raised. Since the output level of the Pitch LFO cannot be less than zero, a negative setting of the Mod Wheel parameter will have no effect unless there is Pitch LFO already occurring because of some other factor like the Level parameter (see the previous paragraph) or Aftertouch (see the next paragraph).

**Aftertouch Depth (-99 to 99)****Page 7**

This parameter sets how much the Aftertouch will increase or decrease the Pitch LFO's Level. A positive value raises the level as more Aftertouch is applied. A negative value will lower the amount of Pitch LFO level as more Aftertouch is applied.

**FILTER LFO**

The Filter LFO function (press [7]) is most often used to apply tremolo-like or "wah-wah" effects to a sound.



*The following Filter LFO variables will affect the sound only if the FILTER LFO DEPTH (on Page 6 of the FILTER function) is set to a value other than 0, or, if Filter LFO is a source in the MOD function.*

*Also note that the Filter LFO may have no effect if some other modulation source or setting has already pushed the filter cutoff frequency to its maximum.*

**Wave (8 choices)****Page 1**

The waveform determines the shape of the LFO. Select either Sine, Triangle, Square, Up Sawtooth, Down Sawtooth, Random+-, Noise or Random+. For a graphic representation of these waveforms and additional discussion on how to use the LFOs, see the diagrams and notes on page 144.

**Speed (00 to 99)****Page 2**

Controls the speed or rate of the LFO. For fast modulation, increase this value. For slower modulation, decrease this value.

**Delay (00 to 99)****Page 3**

This sets the amount of time it takes the LFO to fade in from no modulation to maximum modulation. Sometimes, it is desirable to have modulation come in a moment or two after a note has been played, rather than starting instantly. The higher the value, the more slowly the LFO fades in.

**Trigger (Mono, Poly, Key Mono, or Key Poly)****Page 4**

The Trigger parameter determines how the LFO should be triggered, or started. There are four possible settings: Mono, Poly, Key Mono and Key Poly. A description of these settings is found on page 145.

**Level (00 to 99)****Page 5**

This is the base output level of the Filter LFO. If you want to have a constant value of tremolo to the filter, even without using the Mod Wheel or Aftertouch, set LEVEL above 00. The Mod Wheel and Aftertouch can add to or subtract from this base level. *Example:* If Level is set to 10 and the Mod Wheel parameter (see next paragraph) is set to 10, there will always be some filter tremolo, and raising the Mod Wheel will add more tremolo. On the other hand, if the Mod Wheel parameter is set to -10, raising the Mod Wheel to the top will cancel out all filter tremolo.

**Mod Wheel Depth (-99 to 99)****Page 6**

This parameter sets how much the Mod Wheel will increase or decrease the Filter LFO's Level. A positive value raises the level when the Mod Wheel is moved up, and lowers the level when moved down. Negative settings of this parameter will decrease the output level of the Filter LFO as the Mod Wheel is raised. Since the output level of the Filter LFO cannot be less than zero, a negative setting of the Mod Wheel parameter will have no effect unless there is Filter LFO already occurring because of some other factor like the Level parameter (see the previous paragraph) or Aftertouch (see the next paragraph).

**Aftertouch Depth (-99 to 99)****Page 7**

This parameter sets how much the Aftertouch will increase or decrease the Filter LFO's Level. A positive value raises the level as more Aftertouch is applied. A negative value will lower the amount of Filter LFO level as more Aftertouch is applied.

**AMP LFO**

The Amp LFO function (press [8]) is usually used to add tremolo to a sound.



*The Amp LFO variables will have an effect only if the AMP LFO DEPTH (on page 3 of the AMP/RANGE function) is set to a value other than 0, or if Amp LFO is a source in the MOD function.*

**Wave (8 choices)****Page 1**

The waveform determines the shape of the LFO. Select either Sine, Triangle, Square, Up Sawtooth, Down Sawtooth, Random+-, Noise or Random+. For a graphic representation of these waveforms and additional discussion on how to use the LFOs, see the diagrams and notes on page 144.



**Speed (00 to 99)****Page 2**

Controls the speed or rate of the LFO. For fast modulation, increase this value. For slower modulation, decrease this value.

**Delay (00 to 99)****Page 3**

This sets the amount of time it takes the LFO to fade in from no modulation to maximum modulation. Sometimes, it is desirable to have modulation come in a moment or two after a note has been played, rather than starting instantly. The higher the value, the more slowly the LFO fades in.

**Trigger (Mono, Poly, Key Mono, Key Poly)****Page 4**

The Trigger parameter determines how the LFO should be triggered, or started. There are four possible settings: Mono, Poly, Key Mono and Key Poly. A description of these settings is found in the Trigger section of the Pitch LFO description on page 145.

**Level (00 to 99)****Page 5**

This is the base output level of the Amp LFO. If you want to have a constant value of tremolo, even without using the Mod Wheel or Aftertouch, set Level above 00. The Mod Wheel and Aftertouch can add to or subtract from this base level. *Example:* If Level is set to 10 and the Mod Wheel parameter (see next paragraph) is set to 10, there will always be some tremolo, and raising the Mod Wheel will add more tremolo. On the other hand, if the Mod Wheel parameter is set to -10, raising the Mod Wheel to the top will cancel out all tremolo.

**Mod Wheel Depth (-99 to 99)****Page 6**

This parameter sets how much the Mod Wheel will increase or decrease the Amplitude LFO's Level. A positive value raises the level when the Mod Wheel is moved up, and lowers the level when moved down. Negative settings of this parameter will decrease the output level of the Amp LFO as the Mod Wheel is raised. Since the output level of the Amp LFO cannot be less than zero, a negative setting of the Mod Wheel parameter will have no effect unless there is Amplitude LFO already occurring because of some other factor like the Level parameter (see the previous paragraph) or Aftertouch (see the next paragraph).

**Aftertouch Depth (-99 to 99)****Page 7**

This parameter sets how much the Aftertouch will increase or decrease the Amplitude LFO's Level. A positive value raises the level as more Aftertouch is applied. A negative value will lower the amount of Amp LFO level as more Aftertouch is applied.

## TRACKING GENERATOR

The Tracking Generator function (press [9]) is used to scale a modulation source. For example, normally you could modulate the Amp (volume) of a sound using velocity; the harder you play, the louder the sound gets. The amount of change in volume is equal to the change in velocity; this is called linear control. If instead, however, you set the Tracking Generator's input to "velocity", and then routed the Tracking Generator to the Amp (using the Mod function), you can make your own customized velocity curve!

It might be helpful to think of the Tracking Generator (TG) as a fifth page available to the Mod function. When you choose it as your source on the first page of a Mod (let's say button [0], or Mod 1), you then need to go select the TG's input on button [9], page 1. In effect, the TG's input is *its* "Mod source", and the TG itself becomes a sort of "Mod destination". Modulation input is basically filtered through the TG before it reaches the actual Mod destination on page 2 of Mod 1.

The Tracking Generator divides the range of the input into 11 points (0–10), each of which can be set between 0 and 100. If you boost the value of one of the lower points, you make the input more sensitive in its lower register. By creating a non-linear curve using the velocity example above, you can scale the velocity's control over the sound's volume just the way you want.

When selecting the Tracking Generator as a modulation source in the Mod Function, two choices will be available (TRACKGEN and STEPTRAK). When "TRACKGEN" is selected as the modulation source, the Tracking Generator functions normally, scaling its input as determined by its parameter settings.

When "STEPTRAK" is selected as a modulation source, the Tracking Generator's output will be stepped, or interpolated. This means that instead of scaling the input in a linear fashion from point to point, the input is kept at each point's value setting until it goes beyond the following point's value setting, at which point it jumps to that setting. This feature is very useful in creating "mini-sequences" if the modulation destination is set to "Pitch" and the Tracking Generator's input is an LFO using an "Up Sawtooth" as its waveform. The Z1 HipHop and Z2 EuroDance QCards contain many examples of this *extremely* cool usage of the Tracking Generator.

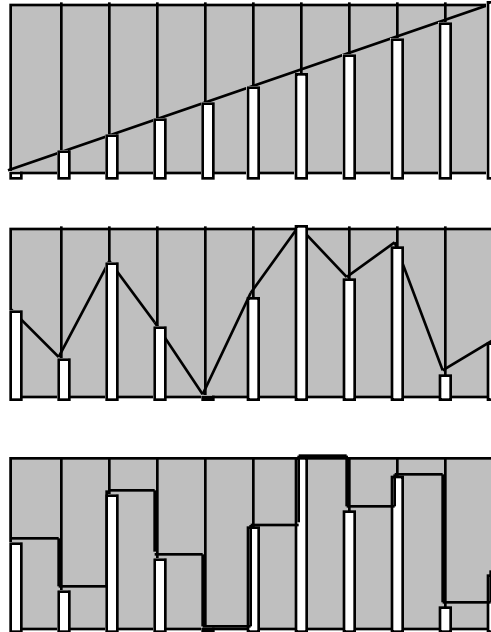

**TIP:** The Tracking Generator can be used to turn a variable control, such as the Mod Wheel or velocity, into a switch by setting all of the points to 0 except for point 10. Only near the maximum input will anything other than 0 come out of the Tracking generator. You can patch the Mod Wheel somewhere else in addition to the Tracking Generator, giving you gradual control of one function with the full range of the Mod Wheel, while switching on a second function only at the top of the wheel.

**Tracking Input**

**Page 1**

Select the input of the Tracking Generator from the following sources:

- Note Number
- Velocity
- Release Velocity
- Aftertouch
- Poly Pressure
- Mod Wheel
- Pitch Wheel
- MIDI Volume
- Sustain Pedal
- Pedal 1
- Pedal 2
- Pitch LFO
- Filter LFO
- Amp LFO
- Pitch Envelope
- Filter Envelope
- Amp Envelope
- Random
- Trig Rate
- Controllers A–D

For detailed descriptions of each of these sources, see the section “Modulation Source” in the Mod section on pages 140-141.

**Tracking Points 0 – 10 (00–100)**

**Pages 2–12**

The remaining pages of the TRACK function control the levels of points 0–10. Select the various Points with the [PAGE] buttons, and change the values in the usual ways. A higher number increases the impact that Point will have on whatever the Mod destination is.

So now that you understand the Tracking Generator a little better, why not try setting up your own velocity curve? Use the TIP at the bottom of the Velocity Curve section as your guide (see page 126).

## PROGRAMMING DRUM SOUNDS IN DRUM MODE

To program a sound in Drum Mode, you must first set the Sound Type to “Drum” for that particular Sound in the Voice Function, page 2 (see page 116). The [0] – [9] buttons are used to select a Drum (1–10), regardless of which Function or Page is selected. For an explanation of the basics of Drum Mode, see page 113.

**TIP:** Here’s a quick way to select the Drum you’d like to edit: If it is on Sound 1, hold down the [00] button and hit the key the Drum is on. If the Drum is on Sound 3, use the [30] button and hit the key.

### VOICE

The Voice function (press [40]) is where you choose the particular sample for the selected Drum (1–10). Similar to the normal Assign Voice function, sounds are divided into groups. After selecting the group (on page 3), you then select the sample within the group (on page 4). Here is a chart listing the various drum samples in their respective groups.

Group	Voice
Kick	FloppyKik1, FloppyKik2, FloppyKikV, MasterKik1, MasterKik2, MasterKikV, MetalKick1, MetalKick2, MetalKickV, GrooveKik1, GrooveKik2, GrooveKikV, Sharp Kick, Tek Kick 1, Tek Kick 2, Tek Kick V, AnalogKik1, AnalogKik2, AnalogKik3, AnalogKikV, Rap Kick
Snare	Fat Wood 1, Fat Wood 2, Fat Wood V, HR Snare 1, HR Snare 2, HR Snare V, MasterSnr1, MasterSnr2, MasterSnrV, Piccolo 1, Piccolo 2, Piccolo V, Electronc1, Electronc2, ElectroncV, Rap Snare1, Rap Snare2, Tek Snare1, Tek Snare2, Tek SnareV, Brush Hit1, Brush Hit2, Brush HitV, Crosstick1, Crosstick2, CrosstickV
Toms	HiRackTom1, HiRackTom2, HiRackTomV, MdRackTom1, MdRackTom2, MdRackTomV, LoRackTom1, LoRackTom2, LoRackTomV, HiFlrTom 1, HiFlrTom 2, HiFlrTom V, MidFlrTom 1, MidFlrTom 2, MidFlrTom V, LowFlrTom1, LowFlrTom2, LowFlrTomV, CanonTomH1, CanonTomH2, CanonTomHV, CanonTomM1, CanonTomM2, CanonTomMV, CanonTomL1, CanonTomL2, CanonTomLV, Hex Tom Hi, Hex Tom Md, Hex Tom Lo, RapTomHi, RapTomMid, RapTomLow
Cymbal	ClosedHat1, ClosedHat2, ClosedHatV, Tight Hat, Loose Hat, Slosh Hat, Foot Hat 1, Foot Hat 2, Velo Hat 1, Velo Hat 2, Velo Hat 3, TekHatClsd, TekHatOpen, RapHatClsd, RapHatHalf, RapHatOpen, CricktHat1, CricktHat2, FilterHat1, FilterHat2, FilterHat3, Ride Cym, Ride Cym 2, RideCym V1, RideCym V2, RideBell 1, RideBell 2, RideBell V, Crash Cym1, Crash Cym2, SplashCym1, SplashCym2, SplashCym3, China Cym1, China Cym2, RapCymbal1, RapCymbal2, RapCymWave, Open Hat 1, Open Hat 2, Open Hat 3, Open Hat V, RideCym V3
Percus	Agogo Hi, Agogo Low, Bongo Hi, Bongo Low, Brake Drum, Cabasa, Castanet, Chimes 1, Chimes 2, Clap Rap, Clap Tek, Clave, Conga Hi, Conga Low, Conga Slap, RapCongaHi, RapCongaMd, RapCongaLo, Rap Rim, Rap Tone, Cowbell, RapCowbell, Cuica, Djembe Hi, Djembe Low, Drumstix, FingerSnap, Guiro Long, Guiro Med, GuiroShort, Ice Block, Kalimba Hi, KalimbaLow, Maracas, SambaWhstl, SambaShort, Shaker1 Hi, Shaker1Low, Shaker2 Hi, Shaker2Low, Sleighb1 1, Sleighb1 2, SteelDrmHi, SteelDrmLo, TablaGa Hi, TablaGaLow, Tabla Ka, TablaNa Hi, TablaNaLow, Tabla Te, TablaTinHi, TablaTinLo, Taiko Hi, Taiko Low, Taiko Rim, Talk Up Hi, Talk Up Lo, TalkDownHi, TalkDownLo, Tambourin1, Tambourin2, Timbale Hi, TimbaleLow, Timpani Hi, TimpaniMid, TimpaniLow, Triangle, TriangleSf, Udu Hi, Udu Mid, Udu Low, Udu Slap, Vibrasmack, WoodBlokHi, WoodBlokLo

Snd FX	Bird Tweet, Bird Chirp, Bird Loop, Fret Noise, Fret Wipe, Orch Hit, Dance Hit, Jungle 1, Jungle 2, Applause, GoatsNails, Brook, Hi Bow, Low Bow, ShapeNzHi, ShapeNzMid, ShapeNzLow, ScrtchPull, ScrtchPush, ScrtchLoop, ScrtchPILp, ScrtcPshLp, RezAttkHi, RezAttkMid, RezAttkLow, RezZipHi, RezZipMid, RezZipLow, Zap 1 Hi, Zap 1 Mid, Zap 1 Low, Zap 2 Hi, Zap 2 Mid, Zap 2 Low, Zap 3 Hi, Zap 3 Mid, Zap 3 Low, FltrNzLoop, Romscape, Rain, Telephone, Sci Loop 1, Sci Loop 2, Sci Loop 3, Bit Field1, Bit Field2, Bit Field3, Bit Field4, Bit Field5, Bit Field6, WavLoop1.0, WavLoop1.1, WavLoop1.2, WavLoop1.3, WavLoop1.4, WavLoop1.5, WavLoop1.6, WavLoop1.7, WavLoop1.8, WavLoop2.0, WavLoop2.1, WavLoop2.2, WavLoop2.3, WavLoop2.4, WavLoop2.5, WavLoop2.6, WavLoop2.7, WavLoop2.8, WavLoop3.0, WavLoop3.1, WavLoop3.2, WavLoop3.3, WavLoop3.4, WavLoop3.5, WavLoop4.0, WavLoop4.1, WavLoop4.2, WavLoop4.3, WavLoop4.4, WavLoop4.5, D-Scrape, D-ScrapeLp
Wave	High Sine, Mid Sine, Low Sine, HiWhitNoiz, MidWhtNoiz, LowWhtNoiz, HiSpectral, LoSpectral, HiCrickets, LoCrickets, Inharm 1, Inharm 2, High Saw, Low Saw, High Pulse, Low Pulse, Hi AcidRez, LowAcidRez, Metal Wave, HiMetlMute, LoMetlMute, Hi DistGtr, LowDistGtr, Hi PwrHarm, LowPwrHarm, Hi FunkGtr, LowFunkGtr, Hi MuteGtr, LowMuteGtr, HiElecHarm, LoElecHarm, ClsclHarm, HiBassHarm, MidBassHrm, LowBassHrm, HiSlpBass, LoSlpBass, Hi BassPop, LowBassPop, Muted Bass, Stik Bass, StudioBass, JazzFingrd, JazzPic, Fretless, AcousBass, 60's Combo, Hi Piano, Mid Piano, Low Piano, High Sync, Low Sync, Hi Synth, LowSynth, Ahhs High, Ahhs Mid, Ahhs Low, Oohs High, Oohs Mid, Oohs Low, TunePipeHi, TunePipeMd, TunePipeLo
Rhythm	Psi Beat 1, Psi Beat 2, Psi Beat 3, Psi Beat 4, Psi Beat 5, Psi Beat 6, Psi Beat 7, Psi Beat 8, Psi Beat 9, Psi Beat10, Psi Beat11, Psi Beat12, Kick Loop1, Kick Loop2, Kick Loop3, Kick Loop4, Kick Loop5, Kick Loop6, Kick Loop7, Kick Loop8, Kick Loop9, KickLoop10, KickLoop11, Snare Lp 1, Snare Lp 2, Snare Lp 3, Snare Lp 4, Snare Lp 5, Snare Lp 6, Snare Lp 7, Snare Lp 8, Snare Lp 9, SnareBeat1, SnareBeat2, SnareBeat3, SnareBeat4, SnareBeat5, Back Beat1, Back Beat2, Back Beat3, Back Beat4, Hat1 Clsd1, Hat1 Clsd2, Hat1 Foot, Hat1 Open1, Hat1 Open2, Hat2 Clsd1, Hat2 Clsd2, Hat2 Foot, Hat2 Open1, Hat2 Open2, Hat3 Clsd1, Hat3 Clsd2, Hat3 Open1, Hat3 Open2, Hat Beat 1, Hat Beat 2, Hat Beat 3, Hat Beat 4, Hat Beat 5, Hat Beat 6, Hat Beat 7, Hat Beat 8, Hat Beat 9, Hat Beat10, Agogo, Bongo Loop, CabasaLoop, CastanetLp, CongaLoop1, Shaker Lp1, Shaker Lp2, SleighLoop, Tabla Ga Lp, Tabla Ka Lp, Tabla Na Lp, Tabla Te Lp, TablaTin Lp, Taiko Loop, PercBeat1, PercBeat2, PercBeat3, PercBeat4, VoiceLoop1, VoiceLoop2, Phonic Loop, SpinalLoop, Tri Loop, Tri Loop 2, Orch Loop

## **LEVEL**

Each Sound lets you create 10 Drums in Drum Mode. The Level function (press [50]) allows you to control the volume, pan position, output assignment and effects send level for each Drum.

### **Volume (00 to 99) Page 1**

This sets the overall volume for a Drum. Higher numbers give higher levels.

### **Pan (<3 to 3>) Page 2**

There are 7 available pan locations in the stereo (two-channel) field: Far left (-3), mid left, near left, center (< >), near right, mid right, and far right (+3).

### **Output (Main, Aux, or Off) Page 3**

The Output parameter has three settings. To send the Drum's output to the Main outputs, select MAIN. To route the dry signal of the Drum to the Aux Outputs, select AUX. To turn off the Drum's direct output altogether, set this parameter to OFF. (Note, however, that the Drum may still feed an Effect Send).

For information on how to set up four discreet outputs, see the Tip on page 119.

### **Effect Level (00 to 99) Page 4**

This section lets you feed the Drum to one of the effect buses for processing (see Part 6 for more information on editing Effects). The Effect Level parameter determines how much of the Drum's sound feeds the chosen effect bus (see below). Higher values mean that the sound will be more "effected".

### **Effect Bus (1 to 4) Page 5**

Selects which of the four buses the Drum will feed, thereby determining which effect(s) will process the Drum.

## **PITCH**

The Pitch function (press [60]) lets you transpose the selected Drum up or down one octave in micro-step (1/4th of a half step) increments, and lets you modulate the Drum's pitch with velocity.

### **Tune (-12.00 to +12.00) Page 1**

Determines the tuning of the selected Drum ( $\pm 12.00$ ).

### **Velocity>Pitch (0 to 7) Page 2**

Determines how much the selected Drum's tuning will be affected by velocity. When this value is set to 7, the Drum will be tuned gradually higher as the associated note is played harder. The softer you play, the less the pitch will be altered from the original tuning.

**FILTER****Velocity>Filter (0 to 3)****Page 1**

The Filter function (press [70]) lets you control the “brightness” of the selected Drum by modulating the filter frequency with velocity. When set to 3, playing the associated note harder will result in a brighter sound (more high frequencies), while playing softer will result in a duller sound (fewer high frequencies). When this parameter is set to 0, velocity will have no effect on the filter.

**AMP/RANGE****Velocity Curve (13 choices)****Page 1**

Page 1 of the Amp/Range function (press [80]) lets you select one of 13 velocity curves. This determines how the Drum will respond to an increase in velocity values from the keyboard or MIDI. A LINEAR curve is the norm, where the velocity values increase the level evenly as you play harder. Many of the Velocity Curves are parts of "sets" which can be used by 2, 3 or 4 Drums in setting up velocity-crossfading, whereby a different Drum is played depending on how hard or soft the keyboard is played. However, each Drum must be in a different Sound layer of the Program in order to be stacked on the same note.

As explained earlier, many of the samples from which you can choose when assigning voices are already "velocity-switching". These samples usually have the word "Velo" or the letter "V" in their names, indicating that there is actually more than one sample per note which can be selected by how hard or soft each note is played. However, the velocity point at which these sounds change is fixed and cannot be altered. If you want to create your own velocity crossfading Drum Mode Program, assign the related versions of the same drum samples ("Conga High" and "Conga Lo") the same key in different Program Sound layers, then use the appropriate velocity curves for each Drum (in a three-way velocity split, Drum 1 would use curve "1 of 3," Drum 2 would use curve "2 of 3" while Drum 3 would use "3 of 3"). For more details about the 13 velocity curves, see the illustration on page 126.

**Note # (000 to 127/C-2 to G8)****Page 2**

Each Drum can be assigned to a single note which will trigger the Drum sound when played. You can also set the note assignment while on this page by holding [80] and tapping a key on the keyboard.



*Only one Drum can be assigned to a single note within a single Program Sound. If more than one Drum in a Sound is assigned to the same note, only the higher-numbered Drum will sound.*

**Note # Range (0 to +3)****Page 3**

Each Drum can be assigned a range of notes above the root note which will trigger the Drum sound when played. A setting of +3 assigns the Drum to a total of 4 consecutive keys.

## **AMP ENVELOPE**

### **Decay (0 to 99, Gate00 to Gate99)**

**Page 1**

Page 1 in the Amp Envelope Function (press [110]) lets you adjust the Decay time of the selected Drum. If this is set to 0, only the very beginning of the drum sample is played whether you hold down the key or not; setting this to 99 will cause the entire drum sample to play. When set above 99, the Decay uses a gated mode. The Decay can still be set between 0 and 99, but in 5-step increments (Gate00, Gate05, etc.). Gating means that the Drum sound will continue to be played as long as the key is held (unless it's a "one-shot" sample like a tom, in which event the sound will stop at the end of the sample). The number after the word "Gate" means that after you let up the key, the drum will decay at that rate. This is useful for longer sounds, like cymbals, when you wish to hear a short crash by playing a short note but can still hear a longer crash by keeping the note held down.

### **Mute Group (Off, 1, 2, or 3)**

**Page 2**

This is an important feature when using multiple sounds of the same instrument. Mute Groups allow multiple Drums to share a single voice. For example, if you have assigned a Closed Hat and an Open Hat to two different notes, playing either note should cut off the other (if the first is sounding when the second is played). This creates a more realistic sound, since an actual Hi Hat is only capable of making one sound at a time.

There are three Mute Groups. In our example above, both Hi Hat Drums would be assigned to Mute Group 1, say, and the additional Mute Groups could be used by other sounds that you wish to cut off each other, but which you do not want to interfere with the Hi Hat sounds.



# SPECIAL PROGRAMMING FUNCTIONS

## COPYING SOUNDS

While editing a Program, it is helpful to be able to copy a Sound to another Sound in either the same Program or a different Program, especially if you are building a split or layered Program

There are three types of Sound Copying operations. You can:

- **Copy from one Sound to another Sound in the Edit Buffer.**

You can use this to quickly double and detune a Program. For example, if you're creating a synth brass program from scratch, once you get the first Sound the way you like it, use this feature to copy Sound 1 to Sound 2. Then detune Sound 2 and you're done!

- **Copy a Sound from a Program in the User Bank into a Sound in the Edit Buffer.**

This is useful, for example, to pull in a string Sound you liked on a given Program in the User bank for quick layering in the current Program.

- **Copy a Sound from the Edit Buffer into a Program in the User bank.**

The opposite of the above example. With this operation, you would first know where you wanted that string Sound to be (the Program number in the User bank *and* the Sound number inside the Program). Then you would call up the Program with the string Sound in it and send it to the other Program. The advantage here is that the Source Sound can be from a Preset Program!

These things can be done very easily from within Store Mode. Here's how:

- ⑩ From Program Edit mode, press [STORE].
- ☛ Press [PAGE ►] once to select the Copy Sound function.
- ① Use the [▲ VALUE] and [VALUE ▼] buttons to select what it is that you wish to copy to another location. There are two different types of choices you can make:
  - a. Select one of the current Program's four Sounds
  - b. Select a Program in the User bank. This becomes the source Program for a Sound you would like to pull into the Edit Buffer.
- ④ Press [PAGE ►] again to advance the cursor to the lower line of the display.
- ⑤ Use the [VALUE] buttons to choose a destination on the bottom line. Depending on the choice you made in step 3, you may only have one choice available to you:
  - a. If you selected a Program number in the top line, you'll only be able to select Sounds 1-4 as the destination Sound. Keep in mind that your choice here will also determine which Sound will be copied *from* the Program number you chose in the top line.
  - b. If you selected one of the current Program's four Sounds in the top line, you'll be able to select any of the other three Sounds in the current Program or one of the Programs in the User bank (000-127). The Sound number in the top line determines the target Sound within the User Program you chose.

- ⑥ Press [STORE] to copy the Sound.

## TO AUDITION PROGRAMS BEFORE STORING

To look for available memory locations to permanently store your Program into, you can move between Program Mode and Mix Mode without losing your changes. This is because Program Mode uses a Program edit buffer, and Mix Mode uses its own Mix edit buffer along with 16 additional Program edit buffers. These buffers are retained when moving between Program Mode and Mix Mode, making it easy to search for a suitable location to store your newly created Program. *Example:* While in Program Edit mode, go to Mix Mode and scroll through the Program list on one of the Channels; while editing a Program from within Mix Mode, go to Program Mode to scroll through the Program list.

The way to tell the difference between a program edited in Program Mode and one edited from Mix Mode is by looking at the display: in Program Edit Mode, "PROG EDIT" appears in the lower-left corner of the display, while in Mix Program Edit Mode, "MIXPROG EDIT" appears.



*You will lose your changes if you remain in the same mode and recall a different Mix/Program by pressing the [0] – [9] or [00] – [120] buttons.*

### To audition Programs before overwriting them with [STORE]

...when editing a Program in Program Mode:

- ⑩ While in Program Edit mode, press [MIX].  
*This selects Mix Play Mode, retaining your edits to the Program in an edit buffer.*
- ♣ Use the [◀ BANK] and [BANK ▶] buttons to select Preset Bank 4; then press [00] and [0] to select the "GM Multi" Mix 00. This is a good "generic" Mix for our auditioning purposes.
- ① Press both [PAGE] buttons simultaneously to select Channel 1.
- ④ Use the [◀ BANK] and [BANK ▶] buttons select the User Bank (or a Card bank).
- ⑤ Use the [0] – [9] or [00] – [120] buttons to go through the Programs in the selected Bank until you find one you wish to overwrite with the new edited Program. Take a note of the number.
- ⑥ Press [PROGRAM] to enter Program Play Mode.  
*This recalls the edit buffer in Program Mode, which still contains your edited Program.*
- ⑦ Press [STORE].  
*The display will show you the "Save Program" screen, with the current bank and number of the Program you are editing on the bottom line (unless you started from a Preset program).*
- ♠ Use a combination of the [CONTROLLER D] slider, the [BANK] buttons, the [VALUE] buttons, and the 23 [SELECTION] buttons to select the Program Number you noted in step 5.
- ⑥ Press [STORE] again.  
**The Program is now stored.**

**To audition Programs before overwriting them with STORE**

...when editing a Program from within Mix Mode:

- ⑩ While in Mix Program Edit mode, press [PROGRAM].  
*This selects Program Play Mode, retaining your edits to the Program in Mix Edit.*
- 🔊 Use the [◀ BANK] and [BANK ▶] buttons select the User Bank (or a Card bank).
- ① Use the [0] – [9] or [00] – [120] buttons to go through the Programs in the selected Bank until you find one you wish to overwrite with the new edited Program. Take a note of the number.
- ④ Press [MIX].  
*This recalls the edit buffer in Mix Mode, which contains your edited Program.*
- ⑤ Press [EDIT SELECT] twice, until “MIXPROG EDIT” appears in the lower-left corner of the display.
- ⑥ Press [STORE].  
*The display will show you the “Save Program” screen, with the current bank and number of the Program you want to store on the bottom line (unless you started from a Preset program).*
- ⑦ Use a combination of the [CONTROLLER D] slider, the [BANK] buttons, the [VALUE] buttons, and the 23 [SELECTION] buttons to select the Program Number you noted in step 3.
- ♣ Press [STORE] again.  
*The Program is now stored.*

At this point your edited Program is stored, but the Mix you were inside before storing the Program still has the Program’s original location stored in memory. If the edited Program was saved to a different Program number, you’ll need to store the Mix as well. So:

- ⑥ Press [MIX].  
*This selects Mix Play Mode.*
- ⑩ Press [STORE] twice.  
*The Mix is now stored.*

## PART 9

# EXTRAS

## A WORD ABOUT THE QS CD-ROM

Included with the QS7.1/8.1 is a CD-ROM containing various useful software programs to use with your QS. These include various Alesis and third-party programs, QS sounds and samples, sequences stored in the MIDI Song File (SMF) format, plus demonstration software we thought you would find interesting. Most of these programs are provided in both Macintosh™ and IBM® PC formats.

### SOUND BRIDGE™

Among the files contained on the CD-ROM is a software program called Sound Bridge™. Sound Bridge is a sound development utility which compiles custom samples from a variety of sources into the QS Synthesis Voice format, and downloads the compiled data to an Alesis PCMCIA Flash RAM Sound Card via MIDI Sysex to a QS-series synth, DM Pro Drum Module, QuadraSynth Plus Piano or S4 Plus. Sound Bridge allows individuals and sound developers to make their own Sound Cards, using whatever samples they want. Sound Bridge makes this possible without having a PCMCIA card burner attached to your computer. All you need is one of the aforementioned synthesizers or rack units.

Sound Bridge creates a QS Voice (multi-sample) by loading Digidesign Sample Cell I or Sample Cell™ II format Instrument files. Using this format, Sound Bridge is able to determine key group and velocity group split points, root notes, sample playback rates, tunings, start points, loop points, and loop tunings. Sound Bridge can also create QS Voices without Sample Cell Instruments by loading single sound files in a variety of formats.

Sound Bridge does NOT require Sample Cell™ hardware. The Sample Cell Instrument file, or sample file, may be loaded directly into Sound Bridge from any disk (i.e. your QS CD-ROM, floppy disk, hard disk, etc.). For example, a user may load data from a Sample Cell-compatible CD-ROM and send this data to one of the aforementioned Alesis unit's PCMCIA Card without using Sample Cell inbetween.

NOTE: If you are interested in creating and/or editing your own custom Sample Cell Instruments, you will need Digidesign's Sample Cell™ hardware and software.

The Sound Bridge folder on the CD-ROM contains the Sound Bridge application, and an electronic manual which will give you all the information you need to know to run Sound Bridge.

Make sure you pay attention to how to set things up on your Mac or PC so that you can transfer files at up to four times the speed of MIDI! This will lop a lot of time off of transmitting huge files to your synth. Again, the CD-ROM tells you all about this.

## USING PCMCIA EXPANSION CARDS

The QS provides two PCMCIA EXPANSION CARD slots, [A] and [B], which are found on the rear panel. These accommodate Alesis QCards and RAM cards. The RAM Card is a type of PCMCIA SRAM or FlashRAM card. We currently offer one which has 512K of memory and will store 8 complete banks. Larger Flash RAM cards can store up to 8MB of sample data using Alesis Sound Bridge software. Each PCMCIA Expansion Card slot can house a card with up to 8 Mb of RAM, for a total of 16 additional megabytes of sound storage.

The QCards are ROM cards, which stands for Read-Only Memory. This means that you can't store ("Write") to them. So the kind of card you need to use for that sort of operation is an SRAM or Flash RAM card.

Note: The cards must be Type 1 PC cards (PCMCIA), and must be either AMD-C series or -D series FLASH cards (or fully compatible). Any SRAM card should work. Many different card sizes from 256K to 8 Megabytes are supported; just make sure they are 5-volt read/write only, and have an access time of 150 nanoseconds or faster.

## SAVING THE USER BANK TO A PCMCIA CARD

The entire contents of the QS's User memory (100 Mixes and 128 Programs) can be stored to an Alesis PCMCIA RAM card inserted into card slot [A] on the QS. Depending on the amount of RAM a particular card has, up to 8 complete banks can be stored onto it.

- ⑩ Insert a card into Sound Card slot A on the back of the QS. Alesis recommends that you use card slot A for all RAM card storage operations.
- ☞ Press [STORE].
- ① Press [◀ PAGE] three times.  
*This selects the "SAVE TO CARD" option. The display will look like this:*

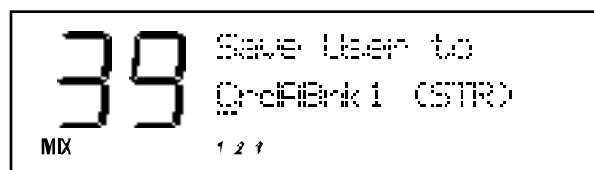

- ④ Use the [CONTROLLER D] slider or the [VALUE] buttons to select a bank location on the card to store to (A1-4, etc.).  
*If the card contains a ROM bank, it will show as Bank 1 and you will be unable to store to it.*
- ⑤ Press [STORE] to transfer the user bank data from the QS onto the card.

If the display reads "CARD A IS WRITE PROTECTED.", switch the write-protect switch on the card to off and repeat the procedure.

---

## LOADING A BANK FROM AN EXTERNAL CARD

The QS can access Program and Mix data directly from a card by using the [BANK] buttons. However, there may be an instance where you want to load a full bank from a RAM card into the User bank.

WARNING! This procedure will overwrite the entire contents of your User bank. There is no Undo function! So be sure this is really what you want to do.

To overwrite the User bank with a Card bank, use this procedure:

- ⑩ Insert the card into the card slot on the back panel.
- ☛ Press [STORE].
- ① Press [◀ PAGE] twice.  
*This selects the "LOAD FROM CARD" option. The display will look like this:*

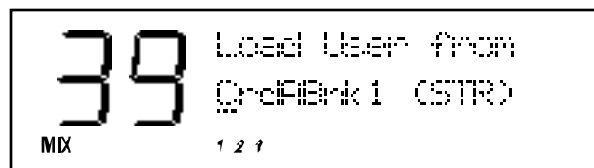

- ④ Use the [CONTROLLER D] slider or the [VALUE] buttons to select the bank on the card you wish to load (A1–A4, etc.).
- ⑤ Press [STORE] to transfer the data from the card into the QS.

## STORING AN INDIVIDUAL PROGRAM OR MIX

You also have the option of storing a Mix or Program directly to a specific location in a RAM Sound Card Bank (instead of transferring the entire Bank) and vice versa. However, the Sound Card you are storing to must be of the current QS Bank format. A Sound Card is formatted whenever an entire QS Bank is stored onto it. If you are using an older QuadraSynth Sound Card that does not use the current Bank format, you will not be able to store individual Mixes or Programs onto it until you store an entire QS Bank onto it first.

- ⑩ Insert a card into PCMCIA Card slot A on the back of the QS. Alesis recommends that you use card slot A for all RAM card storage operations.
- ☛ Select the Program or Mix you wish to transfer to the card.
- ① Press [STORE].
- ④ Use the [BANK] buttons to select a bank location on the card to store to (A1–A4). *If the card contains a ROM bank, it will show as Bank 1 and you will be unable to store to it.*
- ⑤ Use the [00] – [120] and [0] – [9] buttons to select a location in the selected card Bank to save to (000–127 if storing a Program; 00–99 if storing a Mix).
- ⑥ Press [STORE] to transfer the data from the QS onto the card.

If the card is write-protected, or not inserted, or not of the current Bank format, the display will indicate the situation with an error message. If the card is not of the current Bank format, use the “Save To Card” command first (see previous page) to save the entire User Bank to the card. This however will erase all Programs and Mixes in the selected card Bank. If these are important to you, first load them into the User Bank in the QS, and then save them back onto the card in order to re-format the card using the new format.

## LOADING AN INDIVIDUAL PROGRAM OR MIX

You can load a single Mix or Program from a Sound Card into the User Bank, instead of having to load the entire Bank from the Sound Card. To do this, select the Mix or Program in the Sound Card Bank that you wish to copy, then use the Store Function (as described above) to designate a location you wish to store to in the User Bank.

*Note:* When storing a Mix from a Sound Card into the User Bank, the individual Programs used by the Mix will not be moved into the User Program Bank. Once you store a Mix from a Sound Card into the User Bank, it will still look for its Programs in the Sound Card Bank, if that is where it was programmed to look for them in the first place (which is frequently the case).

*Note:* If the Mix or Program you wish to transfer uses samples that reside on a ROM card in slot A or B, you must have the ROM card in that same slot after the transfer in order for that portion of the Program or Mix to sound the same (or at all).



## CARD STORAGE RAMIFICATIONS

It's not uncommon for someone to keep ROM cards in both slots A and B, create their own Mixes which access Programs from both cards, and use a RAM card in Slot A to occasionally to back up their User bank. In this case, there are a few considerations:

Whenever you transfer an internal Bank to a RAM card, the result is that all Mixes in the transferred Bank are changed so that they now access the Programs on the card bank to which the User bank was saved (since they reside there, now), instead of the Programs from the original internal Bank. And, when a Card Bank is transferred to an internal Bank location, the opposite happens – all Programs within a Mix which had previously accessed card bank 1 (for example) now point to the User bank.

However, a problem can arise when you have one or more Mixes in the Bank you are transferring which use Programs from a ROM card in slot A. *Example:* Let's say Mix 00 in the User Bank is made entirely of Programs that are located on Card A Bank 1 (the ROM card). If the ROM card is taken out of slot A, a RAM card is inserted, and the User Bank is transferred to the RAM card's Bank 1, the result will be that Mix 00 in Card Bank 1 now uses only Programs from Card Bank 1. If later you transfer the entire Bank back into the QS, you will find that Mix 00 no longer uses Programs from the Card as it was originally programmed to do.

Here are a few ways to avoid this problem. First, always transfer to a Card Bank that does not include any Programs used by the Mixes in the User Bank. If in the previous example we had transferred the Bank into Card Bank 2, we would not have had a problem, since the Mix would still be using the Programs in Card Bank 1.

Another way to avoid this problem is to transfer the User Bank to a Card Bank, and then immediately store the individual Mix to that same bank on the Card by itself. When a Mix is stored individually to a Card in slot A, it is not modified in any way ; i.e. if it used Programs in the internal Banks, it will still use them even though the Mix and its Programs are in two different locations (the Mix is on the Card but the Programs it uses are stored in the internal Banks).

Finally, you could avoid this situation by always making sure your User Mixes use only Programs located in the User Bank (or that your Card Mixes use only Programs located in that same Card Bank). This could mean individually storing some Programs to or from a Card. Although this is very limiting, it makes things much simpler in the long run.

## **MORE ABOUT SRAM CARDS**

As mentioned before, all card bank storage/retrieval should be carried out in slot A. This assures that when the bank is loaded back into the User bank from the card, the Programs and Mixes within the User bank will be able to find the samples and Programs which originally resided on a card in the A or B slot. This is particularly important for Sounds (samples) which point to the A slot. If the banks are stored to slot B and then reloaded, Programs which used to look to the A slot will look to the B slot for their samples.

Note: If this is done by accident, the SRAM card can be taken out of slot B, placed in slot A, and the bank in question can be loaded into the User bank. This will properly point the Sounds to both the A and B slot.

## **SRAM CARDS AND MIX MODE**

When a Mix is created using Card programs, it counts the number of banks on slot A's card before assigning a number to the first bank on slot B's card. If you remove Card A and then call up the Mix in question, each MIDI channel within the Mix which originally pointed to a Card bank will have its Program Bank number altered by the number of banks which were on Card A. In this example, the Mix will automatically add that number to the Card Program banks within the Mix and point all of those Programs to the wrong place. In other words, if Card A had one bank on it and is removed after the Mix is stored, a Channel within a Mix which used to point to Card A-1 will point to Card B-1, B-1 will point to B-2, and so on.

Likewise, if you plug a Card into slot A when none had been there at the time you stored the Mix, the Card banks within the Mix will be decremented by the same number of banks that exist on the Card you plugged into slot A. If a single-banked ROM card is plugged into slot A in this scenario, then within the Mix Bank B-1 would become A-1, B-2 would become B-1, and so on.

If you plug a Card into Slot A which has more banks than the Card which used to be there, this effect will be even more pronounced. For example, plugging an SRAM Card which has 4 banks into slot A when a ROM card with one bank had been there before will throw the Card Bank indicators off by 3 banks.

Note: this does not affect channels within the Mix which had been pointing to User or Preset Program banks.

**PART 10: APPENDICES**  
**APPENDIX A**

# TROUBLESHOOTING

If you experience problems while operating your QS7.1/QS8.1, please use the following table to check for possible causes and solutions *before* contacting Alesis customer service for assistance. Some of them may seem rather obvious, but you'd be amazed at how easy it can be to overlook the basics.

Symptom	Cause	Solution
The display does not light up when the ON/OFF switch is turned on.	No power.	Check that the power cable is plugged in properly.
No sound.	Bad connections.	Check your audio cables; if necessary, swap cables.
	Volume is turned down.	Raise the [VOLUME] slider or Pedal 1.
	Keyboard Mode is set incorrectly.	Set the Keyboard Mode to NORMAL (Global Editing, display page 6).
	External MIDI device sent Volume (CC#7) or Expression (CC#11) commands with a value approaching 0.	Switch QS from Mix Mode to Program Mode or vice versa. Re-transmit higher values from MIDI device.
MIDI input in Mix mode isn't working (i.e., you can't control your unit via MIDI from a sequencer or some other controller).	Bad connections.	Check MIDI cables.
	MIDI IN is switched off for one or more channels.	Make sure the MIDI IN parameter is turned on for the channel(s) you wish to control via MIDI.
	Keyboard Play Mode is set incorrectly.	Set the Keyboard to Mix Play Mode (push Mix button).
	Serial port enabled.	Set I/O parameter to MIDI (Global Edit Mode, page 15).
Notes sustain continuously.	Sustain pedal was plugged in after power was turned on.	Turn the unit's power off, wait a moment, and then turn it on again.
	Stuck notes due to incomplete MIDI data.	Switch QS from Mix Mode to Program Mode or vice versa.
Notes played from QS have a "doubled" or "flanged" sound	MIDI echo/Thru enabled on external MIDI device or computer	Disable MIDI echo/Thru on external MIDI device

Notes played from QS have a “doubled” or “flanged” sound	MIDI echo/Thru enabled on external MIDI device or computer	Put QS into Out 01 mode (Global Edit Mode, page 6)
Mod Wheel not working well (or at all) QS behaving erratically	Unit was re-initialized with Mod Wheel up	Put Mod Wheel all the way down and re-initialize
	Serial port enabled, no computer or other QS hooked to it	Set I/O parameter to MIDI (Global Edit Mode, page 15) Re-initialize (see below)
LCD shows “ADDRESS ERROR”	Bad Sys-ex data sent to QS via MIDI input	Re-initialize. If it persists, load in known good bank.

## RECOVERING FROM A “CRASH”

If your QS behaves erratically or “freezes” on you, the first thing to try is to switch between Mix and Program modes once. If that doesn’t do anything, turn it off, wait for a moment, and then turn it on again. *WARNING — make sure you turn off any amplification first!*

If your instrument still isn’t working after that, then disconnect the [MIDI IN] cable and repeat the power on/off trick. This ought to work if your problem is being caused by strange MIDI data coming from an external MIDI device.

If neither of these work, you will have to *re-initialize* the instrument.

## RE-INITIALIZING

Re-initializing your QS’s software is strong medicine. It is guaranteed to return the instrument to operational status.

Unfortunately, it will also reset all Global parameters to their factory default settings and empty out the edit buffers, thus losing any unsaved changes you may have made to a Program or Mix. So it isn’t something to be done unless you really need to. (The User Bank will remain untouched, though — all the Programs, Mixes, and Effects stored there will come through the re-initialization just fine.)

Here’s how to do it:

- 1) Turn down the volume on your QS, your mixer, and your amplifier. If you ever forget to do this while re-initializing, you’ll know why we said this first.
- 2) Make sure the [MODULATION] wheel is all the way down. (If it isn’t, then its current position will become what the QS recognizes as “zero” after re-initialization is complete, and you’ll no longer have the full range of possible modulation control.)
- 3) Turn off the power on your QS.
- 4) Hold down buttons [0] and [3] at the same time.
- 5) While holding them down, turn the power back on. You’ll know you were successful if A) there is no name in the LCD display on the top line, and B) the problem is gone!

- 6) Remember to go back into Global Edit mode and set up things the way you had them (things like the Keyboard Mode, Transposition, the A-D MIDI controller number assignments, etc.).

## **CHECKING THE SOFTWARE VERSION**

To find out what version of the operating system software is currently installed in your QS7.1/QS8.1, hold down [PROGRAM] and [0] at the same time and look in the display.

## **MAINTENANCE/SERVICE**

### **CLEANING YOUR QS7.1 / QS8.1**

Before doing cleaning of any kind, always disconnect the AC cord.

For simple dusting and removal of minor dirt, wipe the instrument down with a slightly-damp cloth.

For heavy dirt, use a non-abrasive household cleaner such as Formula 409 or Fantastik. Spray the cleanser onto a cloth, then use the cloth to clean the unit.

**NEVER spray any cleaner directly onto the QS — this can destroy the lubricants used in the switches and controls!**

### **PREVENTATIVE MAINTENANCE**

- Periodically check the AC cord for signs of fraying or damage.
- Make sure the entire bottom surface of the keyboard is supported, so the rest of the unit is not subjected to unnecessary bending.
- Place a dust cover over the QS when it is not in use.

### **REFER ALL SERVICING TO ALESIS**

The QS7.1/QS8.1 synths are some of the most reliable keyboards that can be made using current technology, and should provide years of trouble-free use. If problems should occur, however, do NOT attempt to service the unit yourself. THIS WOULD BE DANGEROUS, thanks to high-level AC and DC electrical voltages present in the instrument's chassis.

Service on this product should be performed only by qualified technicians. THERE ARE NO USER-SERVICEABLE PARTS INSIDE.

## **OBTAINING REPAIR SERVICE**

Before contacting Alesis, please double-check all your audio and MIDI connections, and make sure you've read the manual.

### **U.S. Customers:**

If the problem persists, call Alesis USA at 1-800-525-3747 (1-800-5ALESIS) and request the Product Support department. Or you can e-mail Product Support at Support@alesis1.usa.com. Discuss the problem with one of our technicians; if necessary, you will be given a repair order (RO) number and instructions on how to return the unit. All units must be shipped prepaid and COD shipments will not be accepted.

For prompt service, indicate the RO number on the shipping label. If you do not have the original packing materials, ship the QS in a sturdy carton, with shock-absorbing materials surrounding the unit. Bubble-pack works well, as will any styrofoam pellets that don't contain CFCs. **PROPER PACKAGING IS IMPORTANT:** Shipping damage caused by inadequate packing is not covered by the Alesis warranty.

Before sealing the box, tape a note containing the following items to the top of the defective unit:

- A description of the problem.
- Your name.
- Your phone number (and e-mail, if you have it).
- The address where you want the product returned. (Alesis will pay for standard one-way return shipping on any warranty repairs. Next day service is available for a surcharge.)

Field repairs are not normally authorized during the warranty period, and repair attempts by unqualified personnel may invalidate the warranty.

Service address for customers in the USA:

Alesis Service Department  
12520 Wilkie Ave.  
Hawthorne, CA 90250

### **Customers outside the USA:**

Contact your local Alesis dealer for warranty assistance. The Alesis Limited Warranty applies only to products sold to users in the USA and Canada. Customers outside of the USA and Canada are not covered by this Limited Warranty and may or may not be covered by an independent distributor warranty in the country of sale. Do not return products to the factory unless you have been given specific instructions to do so.

# INDEX

## 4

48 kHz IN connector.....17

## A

### AC power

hookup.....9  
line conditioners and protectors.....9

### Aftertouch

defined.....26  
modulating amplitude.....127  
modulating pitch.....120  
modulating Pitch LFO (vibrato).....146  
modulating the filter.....124

### Alesis

ADAT.....16  
BRC.....17  
contact information.....168  
QCards..... *see* Expansion cards

### Audio

cables.....11  
connections.....10  
levels.....10

AUX outputs.....10, 119

## B

### BANKS

defined.....25  
selecting Banks via MIDI.....25, 52  
selecting Banks with Bank buttons..22, 25

BNC cable.....17

## C

Cards..... *see* Expansion cards

COMPARE Mode.....38

### Connections

digital audio/optical.....16  
pedals and footswitches.....16

CONTROLLER A-D sliders.....19, 27

assigning MIDI controller numbers.....44  
global Modes.....47  
reset function.....47

### Copying

effects between Programs.....66  
Mixes to a card.....36  
Mixes to the User Bank.....36  
Programs to a card.....36  
Programs to the User Bank.....36

## D

Demo sequences.....29

digital audio.....16

DIGITAL OUT port.....16

DISPLAY, tutorial.....21

Double-Button reset procedure.....35

### DRUM Mode

Amp envelope function.....155  
Amp/Range function.....154  
crossfading drums.....154  
Effect Buss/Level.....153  
Filter function.....154  
Gate Mode.....155  
Level function.....153  
Mute Groups.....155  
overview.....113  
Pitch function.....153  
selecting Drums.....151  
Velocity to Pitch parameter.....153  
Voice function.....151–52

## E

### Edit Buffer

copying from one Sound to another.....156  
defined.....101, 157

### Edit mode

Effects.....62  
Mixes.....100  
Programs.....115

EDIT SELECT button.....20, 115

### EFFECTS

basic information.....61  
busses.....*see* Effects Sends  
configurations

1 Reverb.....68  
1 Reverb + EQ.....73  
2 Reverbs.....70  
Lezlie + Reverb.....72  
Overdrive + Lezlie.....74

### Effects Edit functions

Buttons [00]-[30] Effect Sends 1-4.....76  
Button [40] 'Configuration'.....67  
Button [50] 'EQ'.....77  
Button [60] 'Modulation'.....78–80  
list of destinations.....79  
list of sources.....78  
Button [70] 'Lezlie'.....81–82



- Button [80] 'Pitch' .....83–88
  - mono chorus.....84
  - mono flange.....85
  - pitch detune.....86
  - resonator.....86
  - stereo chorus.....84
  - stereo flange.....85
- Button [90] 'Delay' .....89–90
- Button [100] 'Reverb' .....90–95
  - reverb parameters.....93–95
- Button [110] 'Overdrive' .....96
- Button [120] 'Effect Mix' .....97–98
- changing effects via MIDI.....64
- copying effects between Programs.....66
- display changes during editing.....65
- Effect Sends
  - selecting.....76, 102, 119, 153
  - setting levels.....102, 119, 153
  - getting into Effects Edit Mode.....62
  - navigating the edit functions.....63
  - routing through Effects only.....75
  - selecting a configuration.....67
  - selecting effects in a Mix.....63
  - storing effects in Mix Mode.....65
  - storing effects in Program Mode.....65
- overview.....67
- Envelope, defined.....112
- EQ (equalization).....77
- Expansion cards
  - compatible types.....160
  - important user information.....163
  - loading a Bank.....161
  - loading one Program or Mix.....162
  - saving one Program or Mix.....162
  - saving the User Bank.....160
  - using Alesis QCards.....28, 160
  - using Flash RAM.....28, 159, 160
  - using RAM cards.....160
  - using SRAM cards.....28, 160, 164
- Expression pedal.....27
- F**
- Filters
  - cutoff frequency.....110, 123
  - envelopes.....112, 125, 133–35
  - LFOs.....112, 146
  - modulating.....111, 123, 124
- Flash RAM..... *see* Expansion cards
- G**
- General MIDI (described).....172
  - turning GM on/off.....44
- Global Settings
  - chart.....40
- Clock Source/Clock Rate.....48
- CONTROLLER A-D sliders
  - assigning MIDI controller numbers...44
  - mode.....47
  - reset.....47
- editing.....41
- General MIDI.....44
- Input/Output mode.....46
- Keyboard Mode.....43
- Keyboard Velocity Curve.....42
- Keyboard Velocity Scaling.....42
- Master Pitch.....41
- Master Tune.....42
- MIDI Out mode.....47
- MIDI Program Select mode.....46
- Pedal 1 MIDI control number assign.....45
- Pedal 2 MIDI control number assign.....45
- Transpose.....43
- H**
- Headphones jack.....10
- How to Use This Manual.....1
  - Manual conventions.....2
- K**
- Keyboard Velocity Curve.....42
- Keyboard Velocity Scaling.....42
- L**
- LCD Display.....21
- Lezlie effect.....81–82
- LFO, defined.....112
- M**
- Macintosh™, using QS with.....15
- MAIN outputs.....10
- Maintenance
  - cleaning.....167
  - preventative measures.....167
- MIDI
  - advanced hookup
    - QS as controller (master).....54–57
    - transmitting card sequence data.....57
    - transmitting MIDI Panning.....56
    - transmitting MIDI Volume.....56
    - transposing MIDI Note Numbers.....57
  - assigning MIDI controller numbers..44, 45
  - Bank Select messages.....52
  - basic hookup.....12
    - QS as controller (master).....13
    - QS as link in a chain.....13
    - QS as slave.....12
    - QS in computer network.....13
  - changing the MIDI Channel.....30

- external sequencer
    - setting Keyboard Mode.....51
    - tutorial.....50
    - using with serial port.....50
  - General MIDI.....172
    - turning GM on/off.....44
  - General MIDI sound bank, defined.....26
  - global control
    - Clock Source/Clock Rate.....48
    - CONTROLLER A-D sliders
      - assigning MIDI control numbers....44
      - reset.....47
      - selecting the Global Mode.....47
    - Input/Output mode.....46
    - MIDI Out mode.....47
    - Pedals 1 and 2 settings.....45
    - Program Select mode.....46
    - set A-D sliders mode.....47
  - GM Registered Parameter Numbers...173
  - list of Controller Numbers.....171
  - MIDI Channel, changing.....30
  - MIDI defined.....169
  - MIDI features in Mix Mode.....49
  - MIDI hardware.....169
  - MIDI messages
    - Channel Messages.....170
    - System Common Messages.....172
  - MIDI ports, defined.....12
  - Program assign for each Channel.....52
  - QS Implementation Chart.....174
  - System Exclusive
    - editing Programs via SysEx.....59
    - saving Programs via SysEx.....58
  - MIX
    - changing Programs within a Mix.....37
    - copying.....36
    - Effect Buss/Level.....102
    - identifying Programs in a Mix.....32
    - MIDI features overview.....49
    - MIX button.....22
    - Mix Edit functions.....100
      - Controllers.....105
      - Effect.....103
      - Keyboard/MIDI.....104
      - Level.....102
      - Name.....106
      - Pitch.....103
      - understanding edit buffers.....101
    - Mix Mode, defined.....24, 99
    - Mix Play Mode
      - MIDI Channel program assign.....99
      - QS polyphony issues.....99
    - playing Mixes.....31
    - selecting a Mix Bank.....31
    - selecting an individual Mix.....31
    - storing a Mix to a card.....37
    - storing a Mix to the User Bank.....37
    - using BANK buttons in Mix Mode.....22
  - Modulation Matrix.....139–43
    - chart of hardwired mods.....139
  - MODULATION wheel.....19
    - defined.....27
  - Mute Groups (Drum Mode).....116
  - muting/unmuting Sounds.....155
- N**
- Name function
    - chart of characters.....106, 138
    - naming a Mix.....38, 106
    - naming a Program.....38, 138
- O**
- Output jacks.....10
  - Overdrive effect.....96
- P**
- PAGE buttons.....20
  - PC/MAC switch.....14
  - PCMCIA..... *see* Expansion cards
  - Pedals 1 and 2.....16, 45
  - PITCH wheel.....19
    - defined.....26
  - Play Mode Buttons
    - BANK buttons.....22
    - MIX button.....22
    - PROGRAM button.....22
  - PROGRAMS
    - changing the MIDI Channel.....30
    - copying.....36
    - defined.....24
    - Drums.....*see* DRUM Mode
    - Effect Buss/Level.....119
    - Modulation overview.....111–12
    - playing Programs.....30
    - PROGRAM button.....22
    - Program Edit functions
      - Amp envelope.....136–38
      - Amp LFO.....147–48
      - Amp/Range.....126–29
      - Filter.....123–25
      - Filter envelope.....133–35
      - Filter LFO.....146–47
      - Introduction.....115
      - Level.....119
      - Modulation Matrix.....139–43
        - chart of hardwired mods.....139
      - Name.....138

## Index

- Pitch.....120–22
  - Pitch envelope.....130–32
  - Pitch LFO.....144–46
  - Tracking Generator.....149–50
  - Velocity curves.....126
  - Voice.....116–18
  - Programs overview.....107
    - normalized synth voice.....107
  - QS signal flow tutorial.....109–11
  - QS sound generation.....108
  - Signal Processing overview.....112
  - Sound Layers.....109
  - storing a Program to a card.....37
  - storing a Program to the User Bank.....37
  - using BANK buttons in Prog Mode.....22
- Q**
- QS Parameters Index.....175
    - Mix Edit parameters.....177
    - Program Edit parameters.....175
- R**
- RAM cards..... *see* Expansion cards
  - Range
    - Mix mode.....106
    - Program mode.....128
      - creating a ‘hole in the middle’.....128
  - Registered Parameter Numbers (RPNs)..173
  - Re-initializing the QS, procedure.....166
- S**
- Samples
    - chart of drum Groups & Voices.....151–52
    - chart of synth Groups & Voices.....117–18
  - SELECTION (numeric) buttons.....22
  - sequencer, external.....50
  - Sequences
    - playing from a card.....39
    - SEQUENCE button overview.....23
    - transmitting card sequence data.....57
  - SERIAL PORT connector.....14
  - Servicing your QS.....168
  - Sound Bridge™ .....159
  - Sound Groups.....26
  - Sound Overlap.....129
  - Sounds
    - crossfading.....126
    - muting/unmuting.....116
    - selecting Banks.....22, 30, 31
    - selecting Mixes.....31
    - selecting Programs.....30, 37
    - selecting Sounds.....117
  - Special Programming functions
    - copying Sounds.....156
    - program preview before storing.....157
- SRAM..... *see* Expansion cards
- Storing
  - all data to MIDI.....58
  - altered Mixes to a card.....37
  - altered Mixes to the User Bank.....37
  - altered Programs to a card.....37
  - altered Programs to the User Bank.....37
  - STORE button overview.....20
- Sustain footswitch.....27
- SUSTAIN PEDAL input jack.....2
- System Exclusive ("SysEx").....58
- T**
- Tracking Generator.....149–50
  - Transmitting the User bank to MIDI.....58
  - TRANSCOPE
    - Global transpose settings.....43
    - Performance Transposition Chart.....34
    - TRANSCOPE button, overview.....23
    - transposing the keyboard.....33
  - Troubleshooting.....165
    - checking the software version.....167
    - re-initialization procedure.....166
- U**
- User Bank
    - copying to.....155
    - defined.....26
    - storing to MIDI.....58
- V**
- VALUE buttons.....20
  - Velocity
    - adjusting Velocity Curve (global).....42
    - adjusting Velocity Scaling (global).....42
    - chart of curves (Program edit mode)....126
    - crossfading.....126, 154
    - defined.....26
    - linear curve.....126, 154
  - Volume pedal.....27
  - VOLUME slider.....10, 19
- W**
- Windows®, using with QS.....15
- Z**
- Zones
    - Mix mode.....106
    - Program mode.....128
      - creating a ‘hole in the middle’.....128

